



## SSC8P20CN2

### N-Channel Enhancement Mode MOSFET with PNP Transistor

#### ➤ Features

##### N-Channel:

$V_{DS}$	$V_{GS}$	$R_{DS(on)}$ Typ.	$I_D$
20V	$\pm 8V$	200m $\Omega$ @4V5	0.8A
		250m $\Omega$ @2V5	

##### PNP Transistor:

$V_{CB}$	$V_{CE}$	$V_{EB}$	$V_{CESAT}$ Typ.	$I_C$
-40V	-40V	-6V	-180mV	-1A

#### ➤ Pin configuration

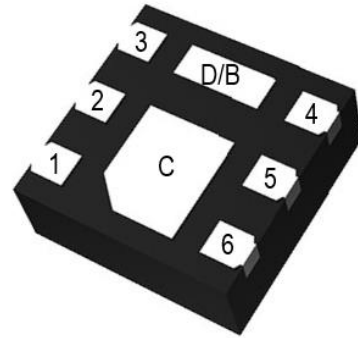

DFN2X2-6L (Bottom View)

#### ➤ Description

The SSC8P20CN2 combines an N-Channel enhancement mode power MOSFET which is produced with high cell density and a Media Power PNP Transistor. The tiny and thin outline saves PCB consumption.

#### ➤ Applications

- Power management
- Charging circuits
- Li-Battery Charging
- Power switches

#### ➤ Ordering Information

Device	Package	Shipping
SSC8P20CN2	DFN2x2-6L	3000/Reel

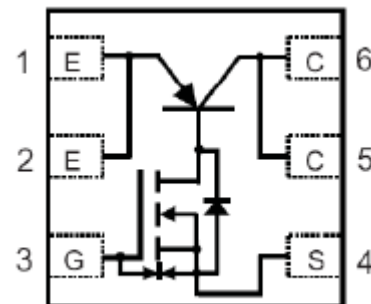

Circuit Diagram

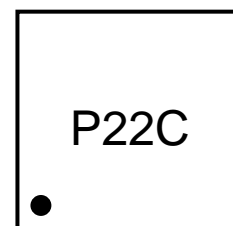

Marking (Top View)



## ➤ Absolute Maximum Ratings ( $T_A=25^\circ\text{C}$ unless otherwise noted)

Symbol	Parameter	Ratings	Unit
<b>N-MOS</b>			
$V_{DSS}$	Drain-to-Source Voltage	20	V
$V_{GSS}$	Gate-to-Source Voltage	$\pm 8$	V
$I_D$	Continuous Drain Current	0.8	A
$I_{DM}$	Pulsed Drain Current	3	A
<b>PNP Transistor</b>			
$V_{CBO}$	Collector-Base Voltage	-40	V
$V_{CEO}$	Collector-Emitter Voltage	-40	V
$V_{EBO}$	Emitter-Base Voltage	-6	V
$I_C$	Collector Current	-1	A
$I_{CM}$	Pulsed Collector Current	-2	A
<b>Power Dissipation and Temperature</b>			
$P_D$	Power Dissipation <sup>a</sup>	2.1	W
$T_A$	Operation Temperature Range	-40 to 85	$^\circ\text{C}$
$T_L$	Lead Temperature	260	$^\circ\text{C}$
$T_J$	Operation Junction Temperature	-55 to 150	$^\circ\text{C}$
$T_{STG}$	Storage Temperature	-55 to 150	$^\circ\text{C}$

## ➤ Thermal Resistance Ratings ( $T_A=25^\circ\text{C}$ unless otherwise noted)

Parameter	Symbol	Value	Unit
Junction-to-Ambient Thermal Resistance <sup>a</sup>	$R_{\theta JA}$	54	$^\circ\text{C}/\text{W}$

Note:

- a. The value of  $R_{\theta JA}$  is measured with the device mounted on 1in2 FR-4 board with 2oz. Copper, in a still air environment with  $T_A=25^\circ\text{C}$ . The Power dissipation  $P_D$  is based on  $R_{\theta JA}$  and the maximum allowed junction temperature of  $150^\circ\text{C}$ . The value in any given application depends on the user's specific board design, and the maximum temperature of  $175^\circ\text{C}$  may be used if the PCB allows it.



➤ **Electrical Characteristics (T<sub>A</sub>=25°C unless otherwise noted)**

Parameter	Symbol	Test Conditions	Min.	Typ.	Max.	Unit
<b>N-Channel Enhancement Mode MOSFET</b>						
Drain-Source Breakdown Voltage	V <sub>(BR)DSS</sub>	V <sub>GS</sub> = 0V, I <sub>D</sub> = 250μA	20			V
Gate Threshold Voltage	V <sub>GS(th)</sub>	V <sub>DS</sub> = V <sub>GS</sub> , I <sub>D</sub> = 250μA	0.35	0.6	1	V
Drain-Source On-Resistance	R <sub>DS(on)</sub>	V <sub>GS</sub> = 4.5V, I <sub>D</sub> = 0.5A		200	600	mΩ
		V <sub>GS</sub> = 2.5V, I <sub>D</sub> = 0.5A		250	850	
		V <sub>GS</sub> = 1.8V, I <sub>D</sub> = 0.35A		350	950	
Zero Gate Voltage Drain Current	I <sub>DSS</sub>	V <sub>DS</sub> = 16V, V <sub>GS</sub> = 0V			1	μA
Gate-Source leak current	I <sub>GSS</sub>	V <sub>GS</sub> = ±8V, V <sub>DS</sub> = 0V			±10	μA
Forward Voltage	V <sub>SD</sub>	V <sub>GS</sub> = 0V, I <sub>S</sub> = 1A			1.3	V
Transconductance	G <sub>FS</sub>	V <sub>DS</sub> = 5V, I <sub>D</sub> = 0.5A		2.2		s
Input Capacitance	C <sub>ISS</sub>	V <sub>DS</sub> = 16V, V <sub>GS</sub> = 0V, f = 200kHz		130		pF
Output Capacitance	C <sub>OSS</sub>			20		
Reverse Transfer Capacitance	C <sub>RSS</sub>			16		
Turn-on Delay Time	T <sub>D(ON)</sub>	V <sub>DS</sub> = 6V, V <sub>GS</sub> = 4.5V, R <sub>L</sub> = 6Ω, R <sub>G</sub> = 6Ω, I <sub>D</sub> = 0.8A		6		ns
Turn-on Rise Time	Tr			23		
Turn-off Delay Time	T <sub>D(OFF)</sub>			42		
Turn-off Fall Time	Tf			78		
<b>PNP Transistor</b>						
Collector-Base Breakdown Voltage	BV <sub>CB0</sub>	I <sub>C</sub> = -50μA, I <sub>E</sub> = 0	-40			V
Collector-emitter Breakdown Voltage	BV <sub>CEO</sub>	I <sub>C</sub> = -1mA, I <sub>B</sub> = 0	-40			V
Emitter -Base Breakdown Voltage	BV <sub>EBO</sub>	I <sub>E</sub> = -50μA, I <sub>C</sub> = 0	-6			V
Collector Cutoff Current	I <sub>CB0</sub>	V <sub>CB</sub> = -20V, I <sub>E</sub> = 0			-0.1	μA
Emitter Cutoff Current	I <sub>EBO</sub>	V <sub>EB</sub> = -4V, I <sub>C</sub> = 0			-0.1	μA
DC Current Gain	h <sub>FE</sub>	V <sub>CE</sub> = -2V, I <sub>C</sub> = -0.5A	100		360	
Collector-Emitter Saturation Voltage	V <sub>CE(sat)</sub>	I <sub>C</sub> = -0.8A, I <sub>B</sub> = -80mA		-0.18	-0.5	V
Base-Emitter Saturation Voltage	V <sub>BE(sat)</sub>	I <sub>C</sub> = -0.8A, I <sub>B</sub> = -80mA			-1.2	V
Transition frequency	f <sub>T</sub>	V <sub>CE</sub> = -6V, I <sub>C</sub> = -20mA, f=30MHz	150			MHz



## ➤ N-Channel Typical Performance Characteristics ( $T_A=25^\circ\text{C}$ unless otherwise noted)

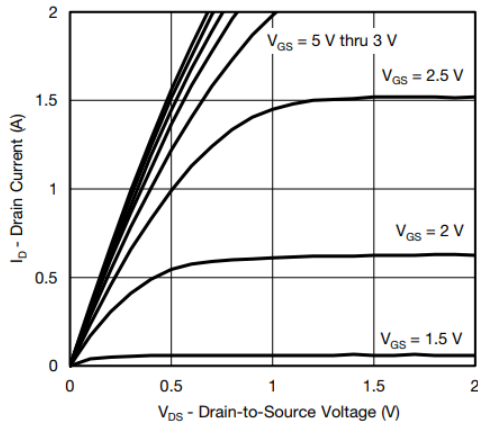

Output Characteristics

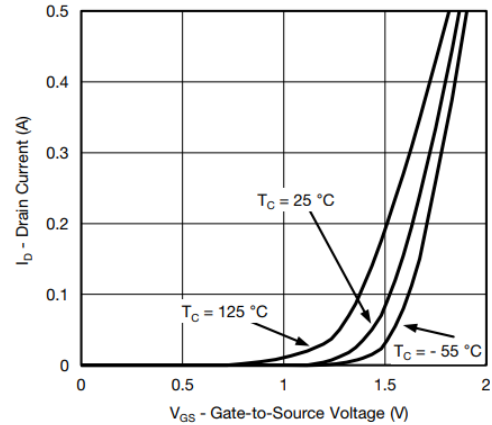

Transfer Characteristics

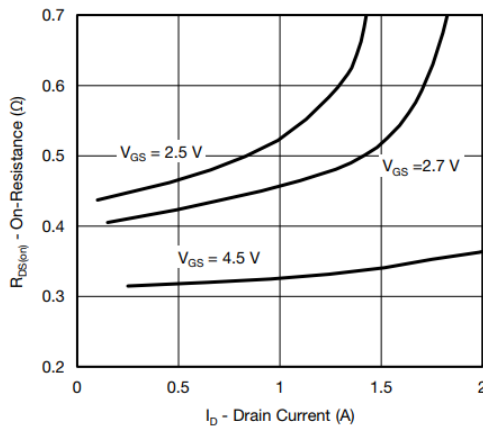

On-Resistance vs. Drain Current and Gate Voltage

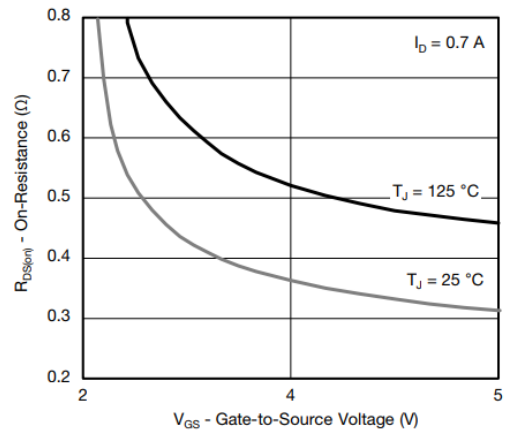

On-Resistance vs. Gate-to-Source Voltage

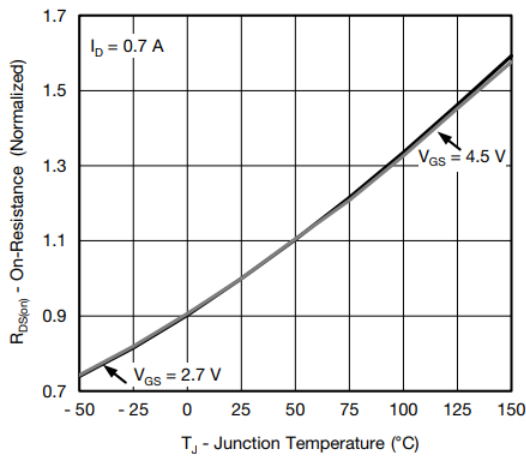

On-Resistance vs. Junction Temperature

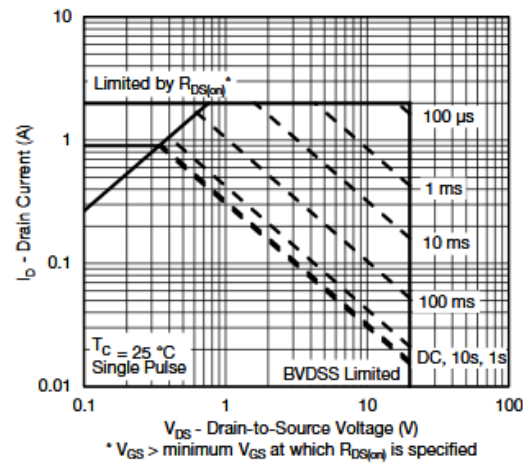

Safe Operating Area, Junction-to-Ambient

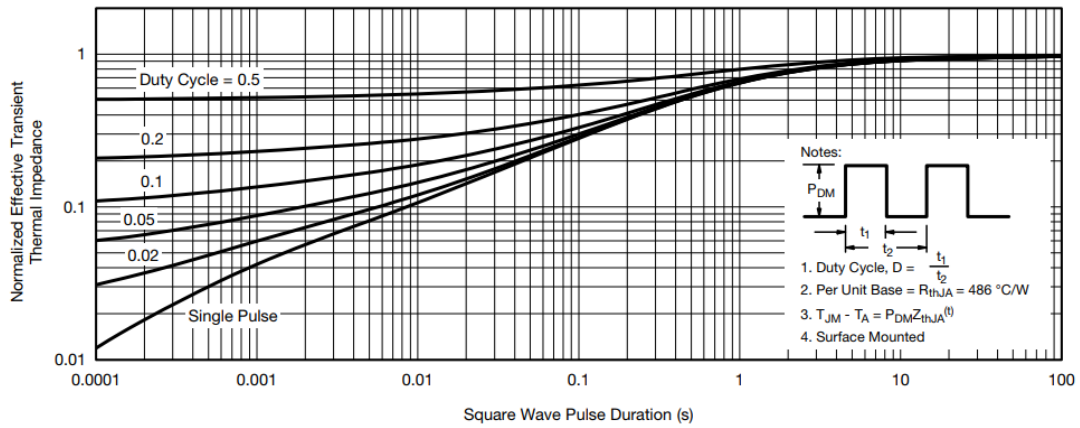

Normalized Thermal Transient Impedance, Junction-to-Ambient



## PNP Transistor Typical Performance Characteristics ( $T_A=25^\circ\text{C}$ )

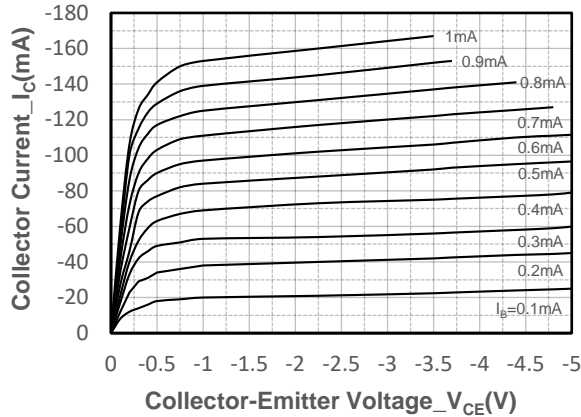

Collector Current vs. Collector-Emitter Voltage

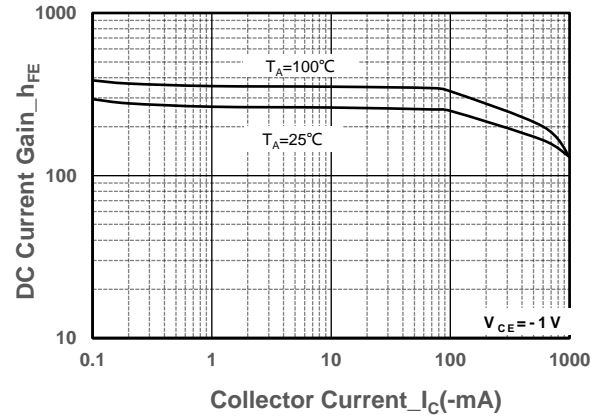

DC Current Gain vs. Collector Current

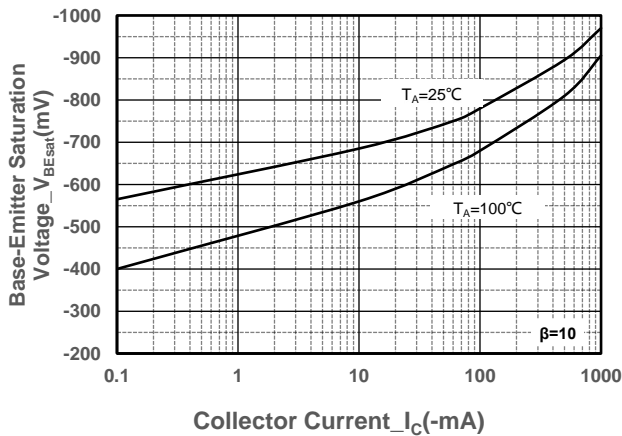

$V_{BE(sat)}$  vs. Collector Current

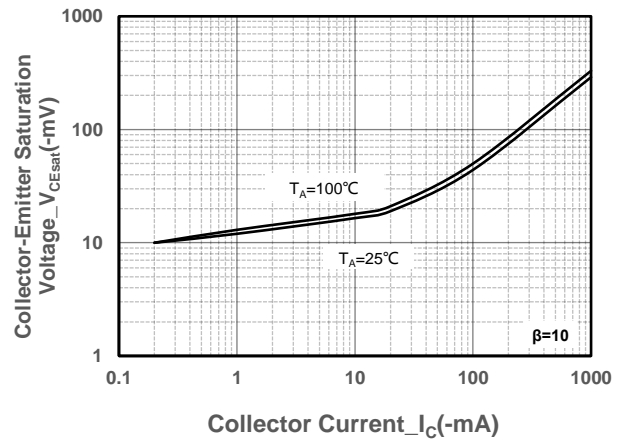

$V_{CE(sat)}$  vs. Collector Current

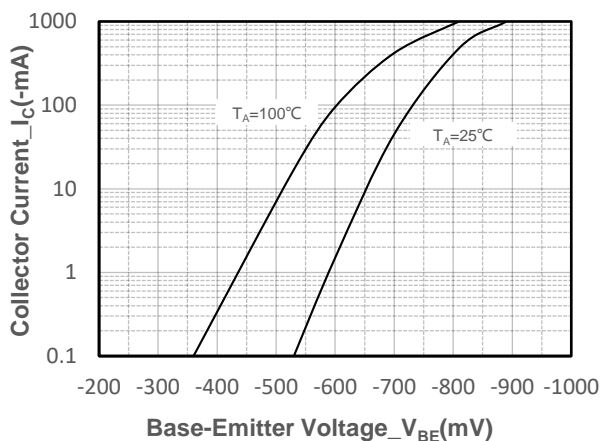

Collector Current vs. Base-Emitter Voltage

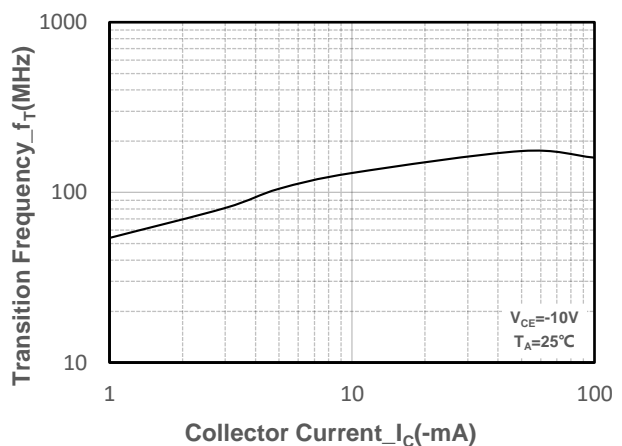

Transition Frequency vs. Collector Current

## ➤ Package Information

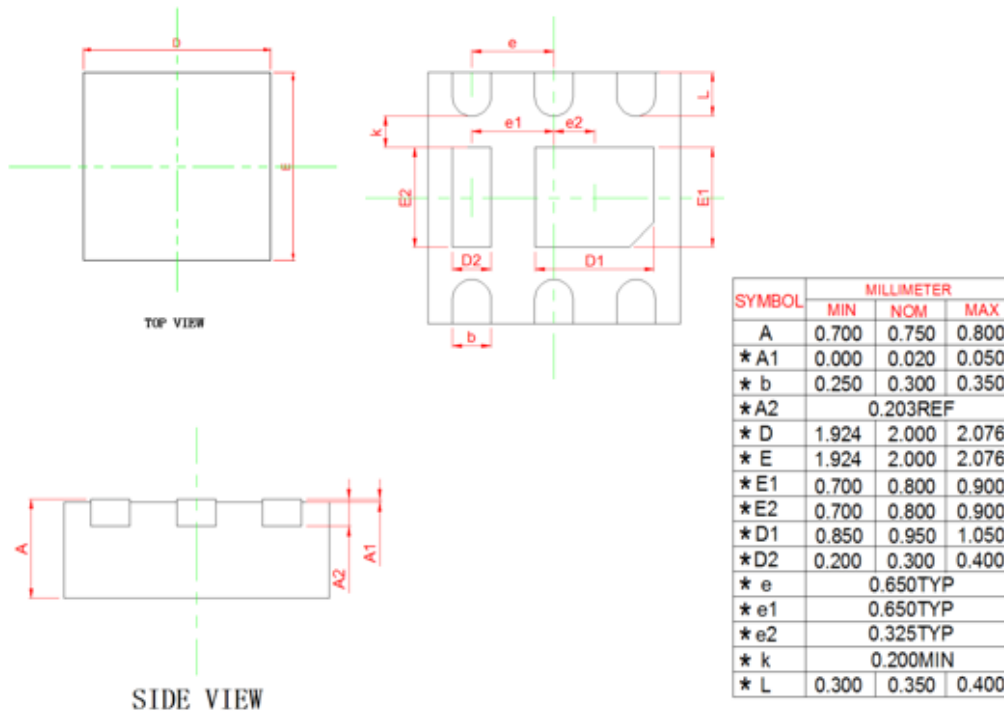

## DISCLAIMER

SSCSEMI RESERVES THE RIGHT TO MAKE CHANGES WITHOUT FURTHER NOTICE TO ANY PRODUCTS HEREIN TO IMPROVE RELIABILITY, FUNCTION OR DESIGN. SSCSEMI DOES NOT ASSUME ANY LIABILITY ARISING OUT OF THE APPLICATION OR USE OF ANY PRODUCT OR CIRCUIT DESCRIBED HEREIN; NEITHER DOES IT CONVEY ANY LICIENCE UNDER ITS PATENT RIGHTS, NOR THE RIGHTS OF OTHERS.

THE GRAPHS PROVIDED IN THIS DOCUMENT ARE STATISTICAL SUMMARIES BASED ON A LIMITED NUMBER OF SAMPLES AND ARE PROVIDED FOR INFORMATIONAL PURPOSE ONLY. THE PERFORMANCE CHARACTERISTICS LISTED IN THEM ARE NOT TESTED OR GUARANTEED. IN SOME GRAPHS, THE DATA PRESENTED MAY BE OUTSIDE THE SPECIFIED OPERATING RANGE (E.G. OUTSIDE SPECIFIED POWER SUPPLY RANGE) AND THEREFORE OUTSIDE THE WARRANTED RANGE.

OUR PRODUCT SPECIFICATIONS ARE ONLY VALID IF OBTAINED THROUGH THE COMPANY'S OFFICIAL WEBSITE, CRM SYSTEM, OR OUR SALES PERSONNEL CHANNELS. IF CHANGES OR SPECIAL VERSIONS ARE INVOLVED, THEY MUST BE STAMPED WITH A QUALITY SEAL AND MARKED WITH A SPECIAL VERSION NUMBER TO BE VALID.