



SSCSBAT54/A/C/SS8 Series

Schottky Barrier Diode

- **Features**

- ✧ Extremely fast switching speed
- ✧ Low forward voltage
- ✧ Very small conduction losses

- **PIN configuration**

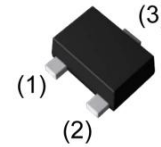

SOT-523

- **Applications**

- ✧ Ultra high-speed switching
- ✧ Voltage clamping
- ✧ Protection circuits
- ✧ Blocking diodes

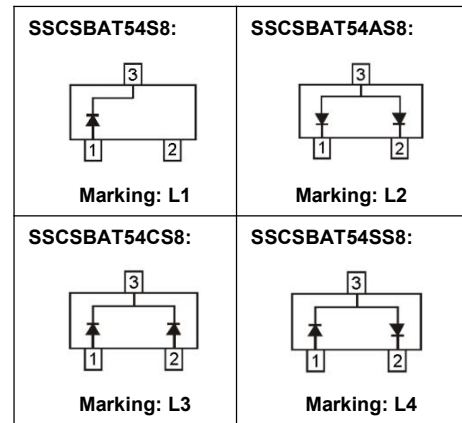

Circuit Diagram

- **Absolute maximum rating @T_A=25°C**

Parameter	Symbol	Value	Unit
Reverse Voltage (DC)	V _R	30	V
Average Rectified Forward Current	I _{FM}	200	mA
Non-repetitive Peak Forward Surge Current @ t=8.3ms	I _{FSM}	600	mA
Power Dissipation	P _D	150	mW
Thermal Resistance from Junction to Ambient	R _{θJA}	667	°C/W
Junction Temperature	T _J	125	°C
Storage Temperature	T _{STG}	-55 ~ +150	°C



● Electrical Characteristics @T_A=25°C

Parameter	Symbol	Conditions	Min.	Typ.	Max.	Unit
Reverse Voltage	V _R	I _R = 100uA	30			V
Forward Voltage	V _F	I _F = 0.1mA			0.23	V
		I _F = 1mA			0.30	V
		I _F = 10mA			0.40	V
		I _F = 30mA			0.50	V
		I _F = 100mA			1.00	V
Reverse Current	I _R	V _R = 25V			2	uA
Junction Capacitance	C _J	V _R =1V,f=1MHz			10	pF
Reverse recovery time	t _{rr}	I _F =I _R =10mA,R _L =100Ω,I _{RR} =0.1I _R			5	ns

● Typical Performance Characteristics

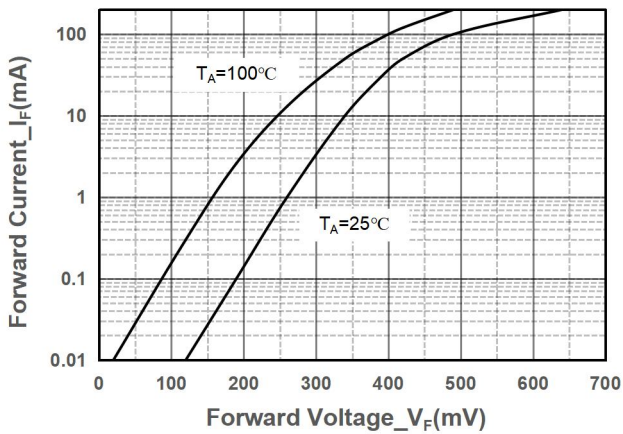

Forward Current vs. Forward Voltage

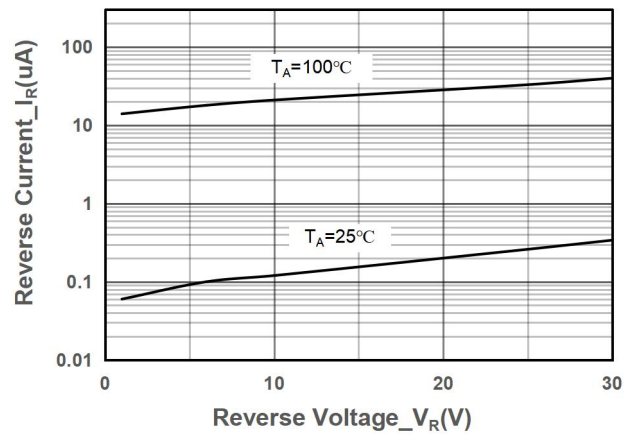

Reverse Current vs. Reverse Voltage

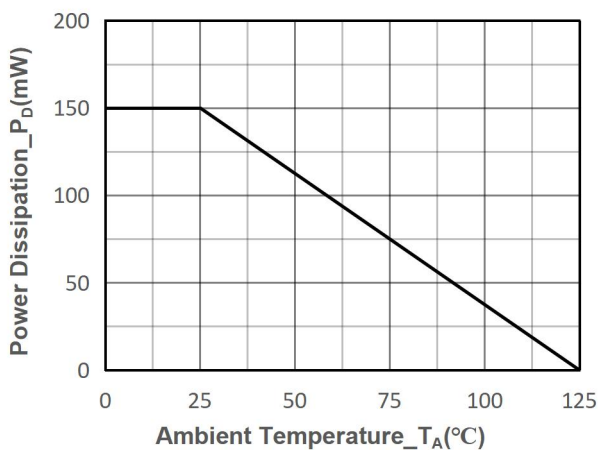

Power Derating vs. Ambient Temperature

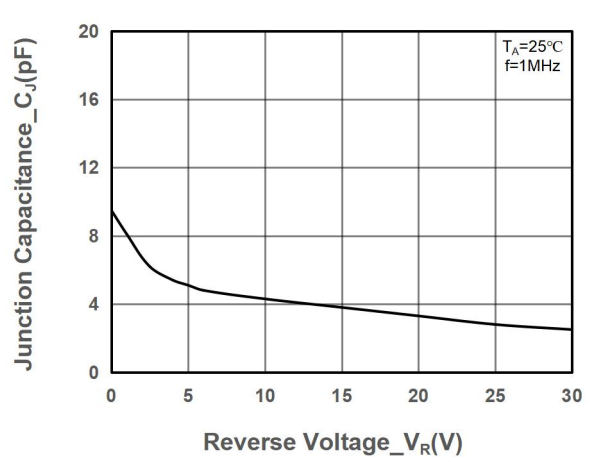

Junction Capacitance vs. Reverse Voltage



● Package Information

Ordering Information

Device	Package	Marking	Qty per Reel	Reel Size
SSCSBAT54S8	SOT-523	L1	3000	7 Inch
SSCSBAT54AS8	SOT-523	L2	3000	7 Inch
SSCSBAT54CS8	SOT-523	L3	3000	7 Inch
SSCSBAT54SS8	SOT-523	L4	3000	7 Inch

Mechanical Data

SOT-523

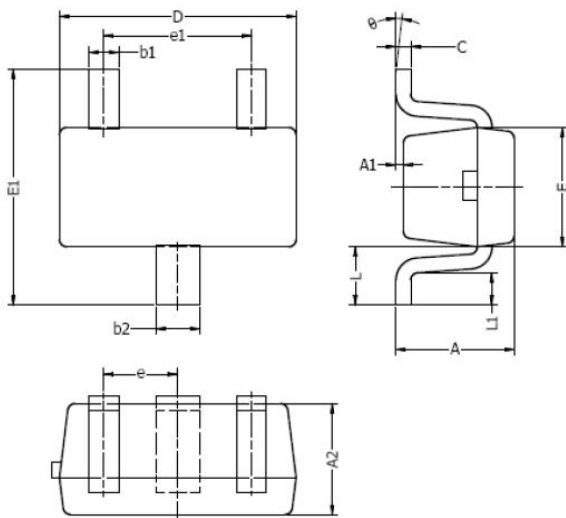

DIM	MILLIMETERS		INCHES	
	MIN	MAX	MIN	MAX
A	0.70	0.90	0.028	0.035
A1	0.00	0.10	0.000	0.004
A2	0.70	0.80	0.028	0.031
b1	0.15	0.25	0.006	0.010
b2	0.25	0.35	0.010	0.014
c	0.10	0.20	0.004	0.008
D	1.50	1.70	0.059	0.067
E	0.70	0.90	0.028	0.035
E1	1.45	1.75	0.057	0.069
e	0.50 TYP.		0.020 TYP.	
e1	0.90	1.10	0.035	0.043
L	0.40 REF.		0.016 REF.	
L1	0.10	0.30	0.004	0.012
theta	0°	8°	0°	8°

Typical Soldering Pattern:

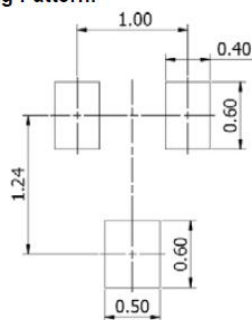

NOTES:

1. Above package outline conforms to JEITA EAIJ ED-7500A SC-75A.
2. Dimensions are exclusive of Burrs, Mold Flash & Tie Bar extrusions.



DISCLAIMER

SSCSEMI RESERVES THE RIGHT TO MAKE CHANGES WITHOUT FURTHER NOTICE TO ANY PRODUCTS HEREIN TO IMPROVE RELIABILITY, FUNCTION OR DESIGN. SSCSEMI DOES NOT ASSUME ANY LIABILITY ARISING OUT OF THE APPLICATION OR USE OF ANY PRODUCT OR CIRCUIT DESCRIBED HEREIN; NEITHER DOES IT CONVEY ANY LICIENCE UNDER ITS PATENT RIGHTS, NOR THE RIGHTS OF OTHERS.

THE GRAPHS PROVIDED IN THIS DOCUMENT ARE STATISTICAL SUMMARIES BASED ON A LIMITED NUMBER OF SAMPLES AND ARE PROVIDED FOR INFORMATIONAL PURPOSE ONLY. THE PERFORMANCE CHARACTERISTICS LISTED IN THEM ARE NOT TESTED OR GUARANTEED. IN SOME GRAPHS, THE DATA PRESENTED MAY BE OUTSIDE THE SPECIFIED OPERATING RANGE (E.G., OUTSIDE SPECIFIED POWER SUPPLY RANGE) AND THEREFORE OUTSIDE THE WARRANTED RANGE.

OUR PRODUCT SPECIFICATIONS ARE ONLY VALID IF OBTAINED THROUGH THE COMPANY'S OFFICIAL WEBSITE, CRM SYSTEM, OR OUR SALES PERSONNEL CHANNELS. IF CHANGES OR SPECIAL VERSIONS ARE INVOLVED, THEY MUST BE STAMPED WITH A QUALITY SEAL AND MARKED WITH A SPECIAL VERSION NUMBER TO BE VALID.