



SSC3946GSG

Dual NPN+PNP Switching Transistor

➤ Features

NPN:

VCB	VCE	VEB	IC
60V	40V	6V	0.2A

PNP:

VCB	VCE	VEB	IC
-40V	-40V	-5V	-0.2A

➤ Pin configuration

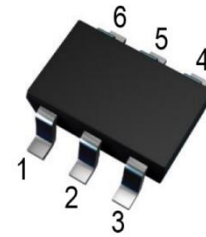

SOT-363

➤ Description

The dual NPN+PNP transistor is composed of a 3904-type NPN and a 3906-type PNP. The device is housed in the SOT-363 package, which is designed for low power amplification and switching.

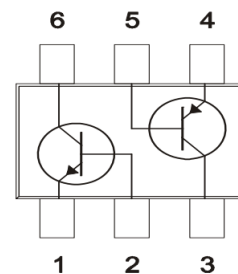

Circuit Diagram

➤ Applications

- General purpose switching and amplification
- Telephony and professional communication equipment

➤ Ordering Information

Device	Package	Shipping
SSC3946GSG	SOT-363	3000/Reel

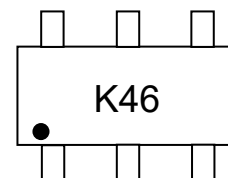

Marking (Top View)



➤ **NPN 3904 Absolute Maximum Ratings**($T_A=25^{\circ}\text{C}$ unless otherwise noted)

Parameter	Symbol	Value	Unit
Collector-Base Voltage	V_{CB0}	60	V
Collector- Emitter Voltage	V_{CEO}	40	V
Emitter-Base Voltage	V_{EBO}	5	V
Collector Current-Continuous	I_c	0.2	A
Collector Power Dissipation	P_C	200	mW
Junction Temperature	T_J	-55 to 150	$^{\circ}\text{C}$
Storage Temperature	T_{STG}	-55 to 150	$^{\circ}\text{C}$

➤ **NPN 3904 Electrical Characteristics** ($T_A=25^{\circ}\text{C}$ unless otherwise noted)

Parameter	Symbol	Test Conditions	Min.	Typ.	Max.	Unit
Collector-Base Breakdown Voltage	BV_{CB0}	$I_c=10\mu\text{A}, I_E=0$	60			V
Collector-emitter Breakdown Voltage	BV_{CEO}	$I_c=1\text{mA}, I_B=0$	40			V
Emitter -Base Breakdown Voltage	BV_{EBO}	$I_E=10\mu\text{A}, I_c=0$	5			V
Collector Cutoff Current	I_{CEX}	$V_{CE}=30\text{V}, V_{EB}=3\text{V}$			0.05	μA
Collector Cutoff Current	I_{CBO}	$V_{CB}=30\text{V}, I_E=0$			0.5	μA
Emitter Cutoff Current	I_{EBO}	$V_{EB}=3\text{V}, I_c=0$			0.05	μA
DC Current Gain	h_{FE}	$V_{CE}=1\text{V}, I_c=0.1\text{mA}$	40			
		$V_{CE}=1\text{V}, I_c=1\text{mA}$	70			
		$V_{CE}=1\text{V}, I_c=10\text{mA}$	100		300	
		$V_{CE}=1\text{V}, I_c=50\text{mA}$	60			
		$V_{CE}=1\text{V}, I_c=100\text{mA}$	30			
Collector-Emitter Saturation Voltage	$V_{CE(sat)1}$	$I_c=10\text{mA}, I_B=1\text{mA}$			0.2	V
	$V_{CE(sat)2}$	$I_c=50\text{mA}, I_B=5\text{mA}$			0.3	V
Base-Emitter Saturation Voltage	$V_{BE(sat)1}$	$I_c=10\text{mA}, I_B=1\text{mA}$	0.65		0.85	V
	$V_{BE(sat)2}$	$I_c=50\text{mA}, I_B=5\text{mA}$			0.95	V
Transition frequency	f_T	$V_{CE}=20\text{V}, I_c=10\text{mA}$ $f=100\text{MHz}$	300			MHz
Collector output capacitance	C_{ob}	$V_{CB}=5\text{V}, I_E=0, f=1\text{MHz}$			4	pF
Noise figure	N_F	$V_{CE}=5\text{V}, I_c=0.1\text{mA},$ $f=1\text{kHz}, R_S=1\text{K}\Omega$			5	dB
Delay Time	t_d	$V_{CC}=3\text{V}, V_{BE(off)}=-0.5\text{V}$ $I_c=10\text{mA}, I_{B1}=1\text{mA}$			35	ns
Rise Time	t_r	$V_{CC}=3\text{V}, V_{BE(off)}=-0.5\text{V}$ $I_c=10\text{mA}, I_{B1}=1\text{mA}$			35	ns
Storage Time	t_s	$V_{CC}=3\text{V}, I_c=10\text{mA}$ $I_{B1}= -I_{B2}=1\text{mA}$			200	ns
Fall Time	t_f	$V_{CC}=3\text{V}, I_c=10\text{mA}$ $I_{B1}= -I_{B2}=1\text{mA}$			50	ns



➤ **PNP 3906 Absolute Maximum Ratings ($T_A=25^{\circ}\text{C}$ unless otherwise noted)**

Parameter	Symbol	Value	Unit
Collector-Base Voltage	V_{CB0}	-40	V
Collector- Emitter Voltage	V_{CEO}	-40	V
Emitter-Base Voltage	V_{EBO}	-5	V
Collector Current-Continuous	I_C	-0.2	A
Collector Power Dissipation	P_C	200	mW
Junction Temperature	T_J	-55 to 150	$^{\circ}\text{C}$
Storage Temperature	T_{STG}	-55 to 150	$^{\circ}\text{C}$

➤ **PNP 3906 Electrical Characteristics ($T_A=25^{\circ}\text{C}$ unless otherwise noted)**

Parameter	Symbol	Test Conditions	Min.	Typ.	Max.	Unit
Collector-Base Breakdown Voltage	BV_{CB0}	$I_C=-10\mu\text{A}, I_E=0$	-40			V
Collector-emitter Breakdown Voltage	BV_{CEO}	$I_C=-1\text{mA}, I_B=0$	-40			V
Emitter -Base Breakdown Voltage	BV_{EBO}	$I_E=-10\mu\text{A}, I_C=0$	-5			V
Collector Cutoff Current	I_{CEX}	$V_{CE}=-30\text{V}, V_{EB}=-3\text{V}$			-50	nA
Collector Cutoff Current	I_{CBO}	$V_{CB}=-30\text{V}, I_E=0$			-100	nA
Emitter Cutoff Current	I_{EBO}	$V_{EB}=-5\text{V}, I_C=0$			-100	nA
DC Current Gain	h_{FE}	$V_{CE}=-1\text{V}, I_C=-10\text{mA}$	100		300	
		$V_{CE}=-1\text{V}, I_C=-0.1\text{mA}$	60			
		$V_{CE}=-1\text{V}, I_C=-100\text{mA}$	30			
Collector-Emitter Saturation Voltage	$V_{CE(sat)}$	$I_C=-50\text{mA}, I_B=-5\text{mA}$			-0.4	V
Base-Emitter Saturation Voltage	$V_{BE(sat)}$	$I_C=-50\text{mA}, I_B=-5\text{mA}$			-0.95	V
Transition frequency	f_T	$V_{CE}=-20\text{V}, I_C=-10\text{mA}$ $f=100\text{MHz}$	250			MHz
Delay Time	t_d	$V_{CC}=-3\text{V}, V_{BE}=0.5\text{V}$ $I_C=-10\text{mA}, I_{B1}=-1\text{mA}$			35	ns
Rise Time	t_r				35	ns
Storage Time	t_s	$V_{CC}=-3\text{V}, I_C=-10\text{mA}$ $I_{B1}=-I_{B2}=-1\text{mA}$			225	ns
Fall Time	t_f				75	ns



➤ **NPN 3904 Typical Performance Characteristics ($T_A=25^\circ\text{C}$ unless otherwise noted)**

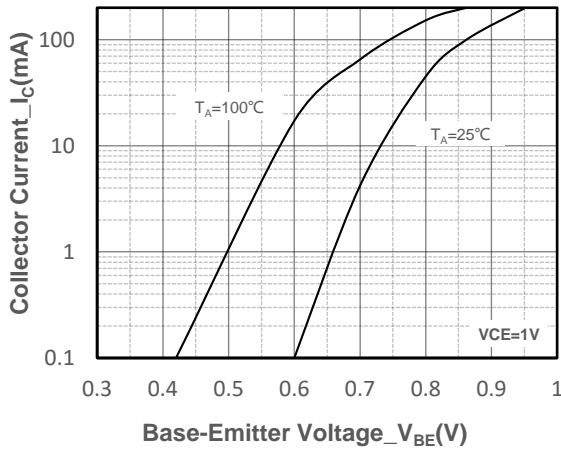

Collector Current vs. Base-Emitter Voltage

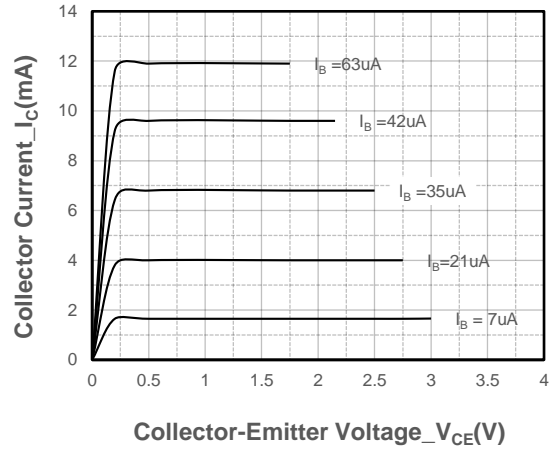

Collector Current vs. Collector-Emitter Voltage

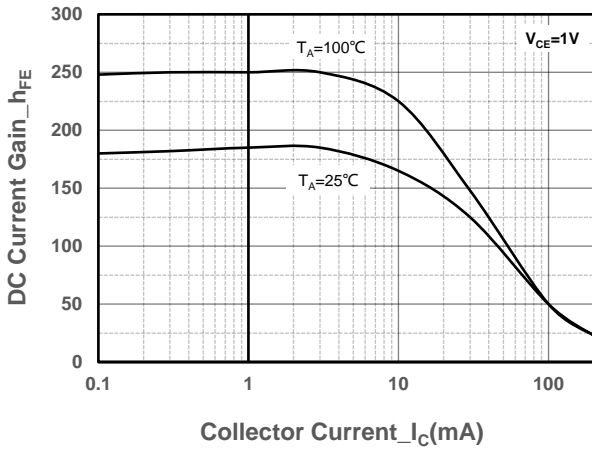

DC Current Gain vs. Collector Current

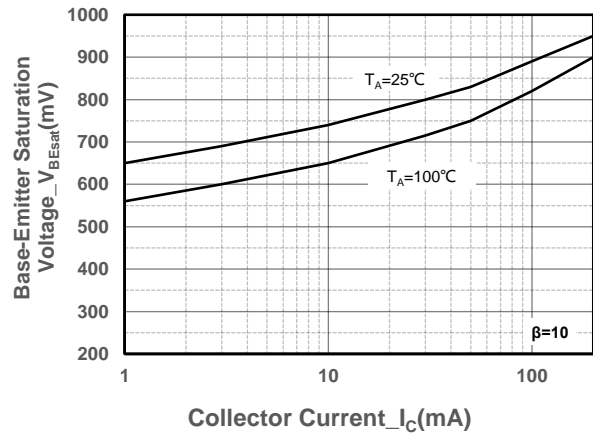

$V_{BE(sat)}$ vs. Collector Current

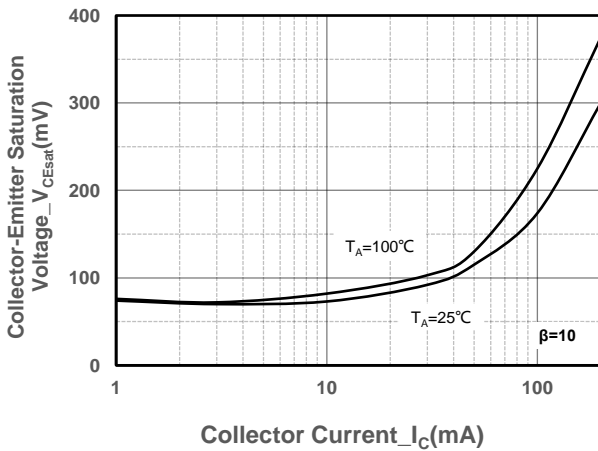

$V_{CE(sat)}$ vs. Collector Current

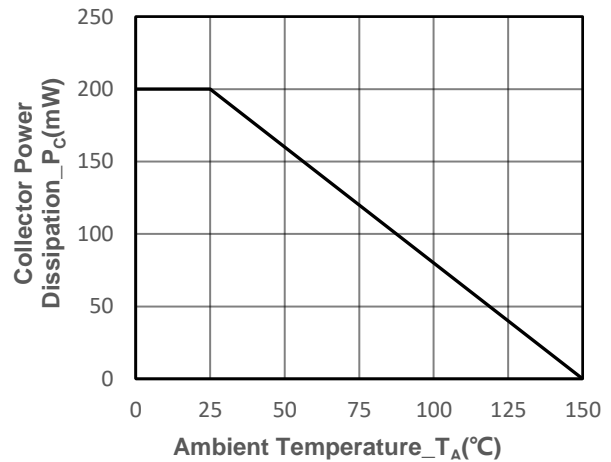

Power derating vs. Ambient temperature



➤ **PNP 3906 Typical Performance Characteristics ($T_A=25^\circ\text{C}$ unless otherwise noted)**

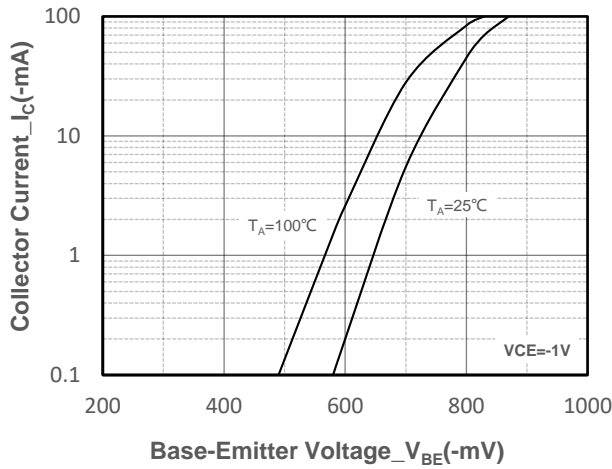

Collector Current vs. Base-Emitter Voltage

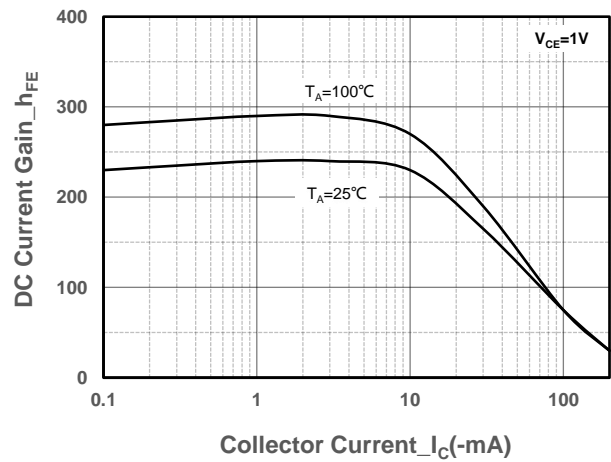

DC Current Gain vs. Collector Current

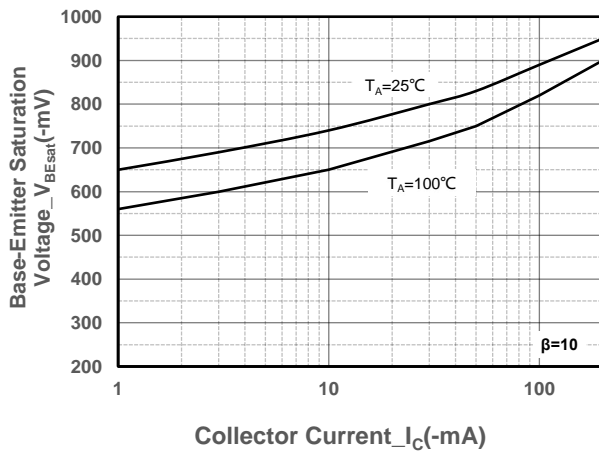

$V_{BE(sat)}$ vs. Collector Current

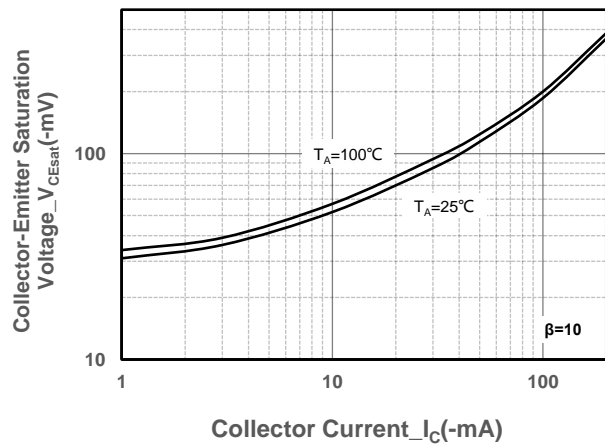

$V_{CE(sat)}$ vs. Collector Current

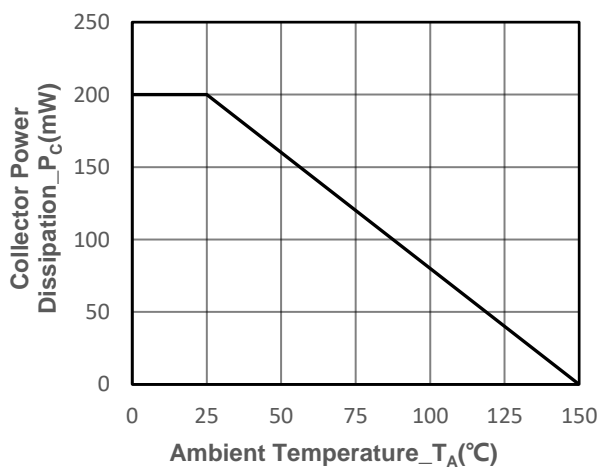

Power derating vs. Ambient temperature

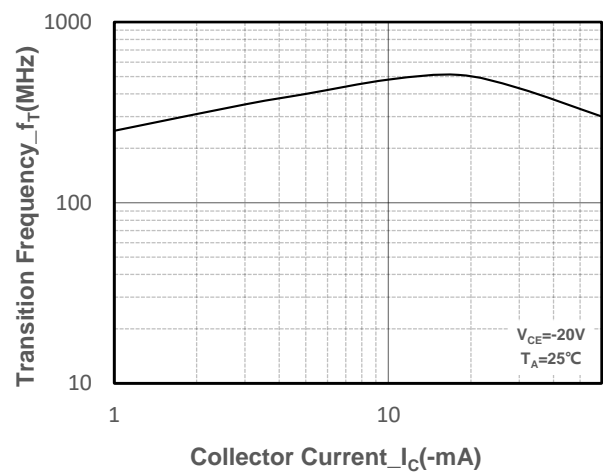

Transition Frequency vs. Collector Current

➤ Package Information

SOT-363

TOP VIEW

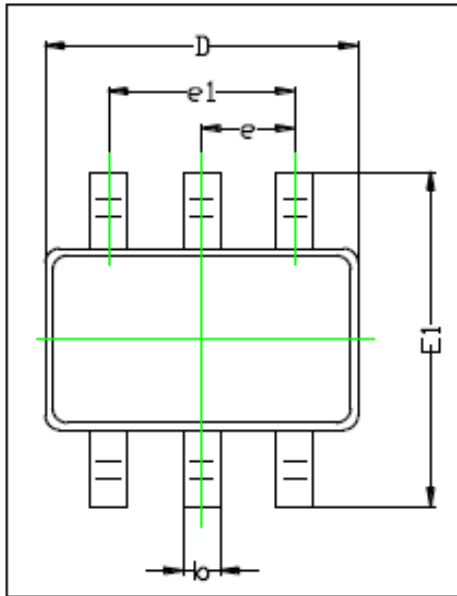

SIDE VIEW

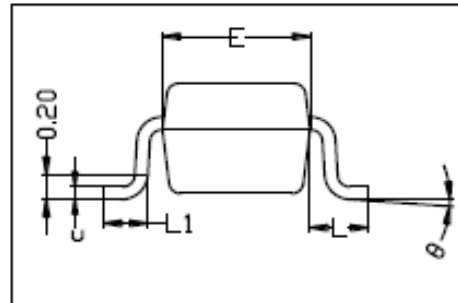

SOLDERING PATTERN

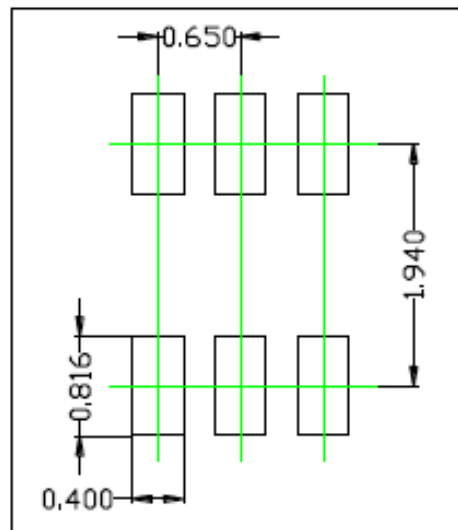

FRONT VIEW

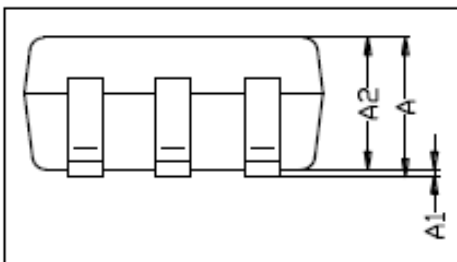

SYMBOL	DIMENSIONS IN MILLIMETER	
	MIN	MAX
A	0.900	1.000
A1	0.000	0.100
A2	0.900	1.000
b	0.150	0.300
c	0.100	0.150
D	2.000	2.200
E	1.150	1.350
E1	2.150	2.400
e	0.650 TYP.	
e1	1.200	1.400
L	0.525 REF.	
L1	0.260	0.450
θ	0°	8°



DISCLAIMER

SSCSEMI RESERVES THE RIGHT TO MAKE CHANGES WITHOUT FURTHER NOTICE TO ANY PRODUCTS HEREIN TO IMPROVE RELIABILITY, FUNCTION OR DESIGN. SSCSEMI DOES NOT ASSUME ANY LIABILITY ARISING OUT OF THE APPLICATION OR USE OF ANY PRODUCT OR CIRCUIT DESCRIBED HEREIN; NEITHER DOES IT CONVEY ANY LICIENCE UNDER ITS PATENT RIGHTS, NOR THE RIGHTS OF OTHERS.

THE GRAPHS PROVIDED IN THIS DOCUMENT ARE STATISTICAL SUMMARIES BASED ON A LIMITED NUMBER OF SAMPLES AND ARE PROVIDED FOR INFORMATIONAL PURPOSE ONLY. THE PERFORMANCE CHARACTERISTICS LISTED IN THEM ARE NOT TESTED OR GUARANTEED. IN SOME GRAPHS, THE DATA PRESENTED MAY BE OUTSIDE THE SPECIFIED OPERATING RANGE (E.G. OUTSIDE SPECIFIED POWER SUPPLY RANGE) AND THEREFORE OUTSIDE THE WARRANTED RANGE.

OUR PRODUCT SPECIFICATIONS ARE ONLY VALID IF OBTAINED THROUGH THE COMPANY'S OFFICIAL WEBSITE, CRM SYSTEM, OR OUR SALES PERSONNEL CHANNELS. IF CHANGES OR SPECIAL VERSIONS ARE INVOLVED, THEY MUST BE STAMPED WITH A QUALITY SEAL AND MARKED WITH A SPECIAL VERSION NUMBER TO BE VALID.