



SSCSBAV23AS6 /SSCSBAV23CS6 /SSCSBAV23SS6

Fast Switching Diode

● Features

- ✧ Fast Switching Speed
- ✧ Ultra-Small Surface Mount Package
- ✧ Low Reverse Leakage Current
- ✧ Ideal for Battery Powered Portable Applications
- ✧ RoHS Compliant/Green EMC
- ✧ Moisture Sensitivity: Level 3 per J-STD-020

● PIN configuration

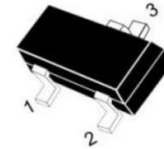

SOT-23

✧ Applications

- ✧ High speed switching for detection
- ✧ Battery Powered Portable
- ✧ Mobile phones, laptops and other electronic devices

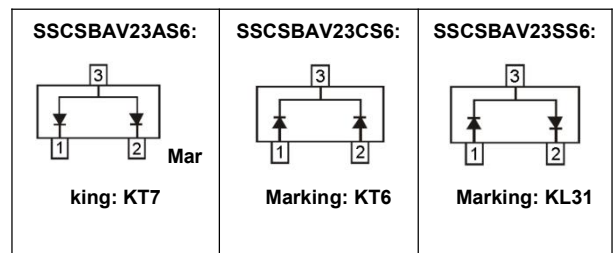

Circuit Diagram

● Absolute maximum rating @T_A=25°C

Parameter	Symbol	Value	Unit
Peak Repetitive Reverse Voltage	V _{RRM}	250	V
Working Peak Reverse Voltage	V _{RWM}	250	V
RMS Reverse Voltage	V _{R(RMS)}	175	V
Average Rectified Forward Current	I _{FM}	225	mA
Non-repetitive Peak Forward Surge Current @ t=8.3ms	I _{FSM}	1.7	A
Power Dissipation	P _D	350	mW
Thermal Resistance from Junction to Ambient	R _{θJA}	357	°C/W
Junction Temperature	T _J	125	°C
Storage Temperature	T _{STG}	-55 ~ +150	°C



● **Electrical Characteristics @ $T_A=25^\circ\text{C}$**

Parameter	Symbol	Conditions	Min.	Typ.	Max.	Unit
Reverse Voltage	V_R	$I_R = 100\mu\text{A}$	250			V
Forward Voltage	V_F	$I_F = 100\text{mA}$			1	V
		$I_F = 200\text{mA}$			1.25	V
Reverse Current	I_R	$V_R = 250\text{V}$			0.1	μA
Capacitance between terminals	C_T	$V_R = 0\text{V}, f = 1\text{MHz}$			5	pF
Reverse recovery time	t_{rr}	$I_F=I_R=30\text{mA}, R_L=100\Omega, I_{rr}=0.1I_R$			50	ns

● **Typical Performance Characteristics**

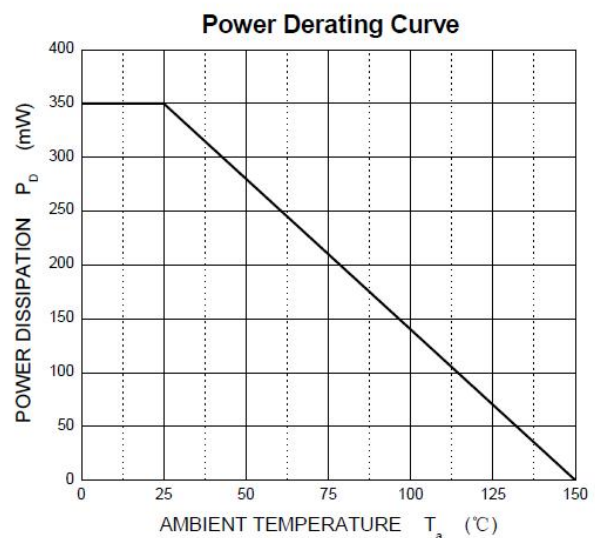
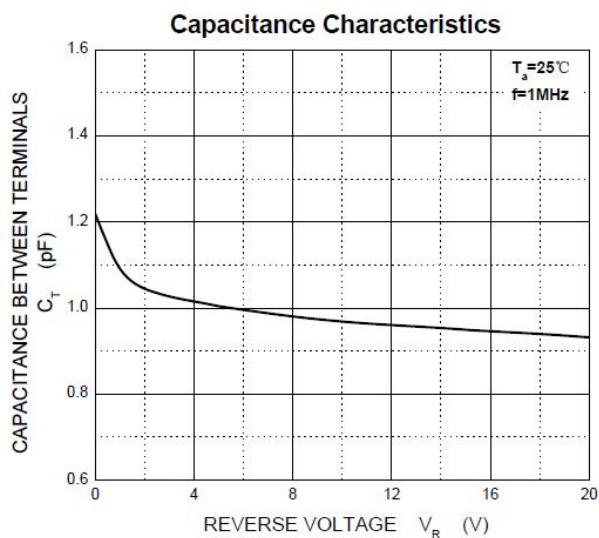
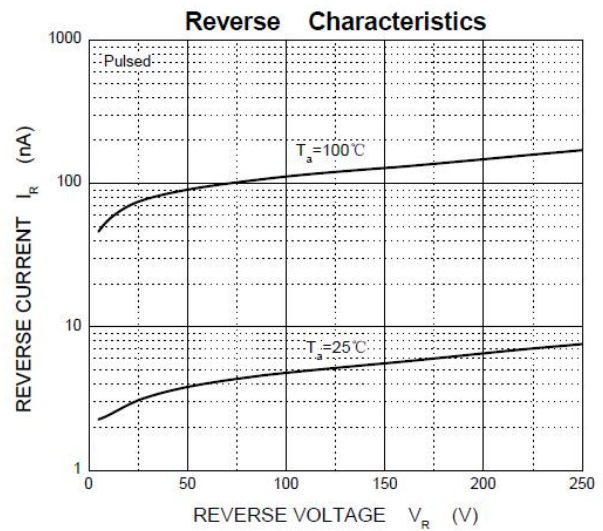
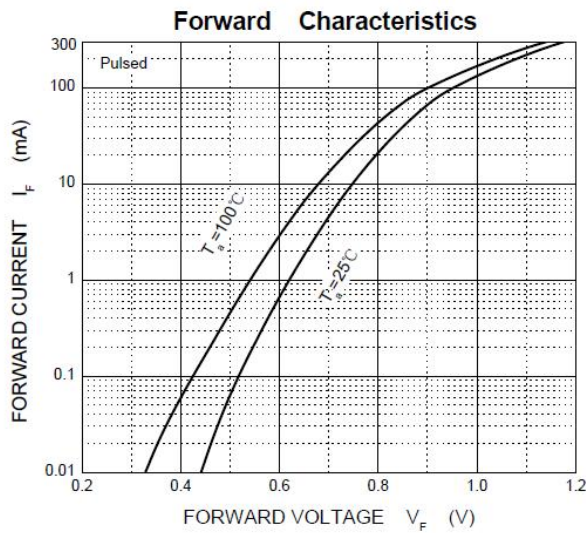



SSCSBAV23AS6/SSCSBAV23CS6 /SSCSBAV23SS6

● Package Information

Ordering Information

Device	Package	Marking	Qty per Reel	Reel Size
SSCSBAV23AS6	SOT-23	KT7	3000	7 Inch
SSCSBAV23CS6	SOT-23	KT6	3000	7 Inch
SSCSBAV23SS6	SOT-23	KL31	3000	7 Inch

Mechanical Data

Case: SOT-23

Case Material: Molded Plastic. UL Flammability

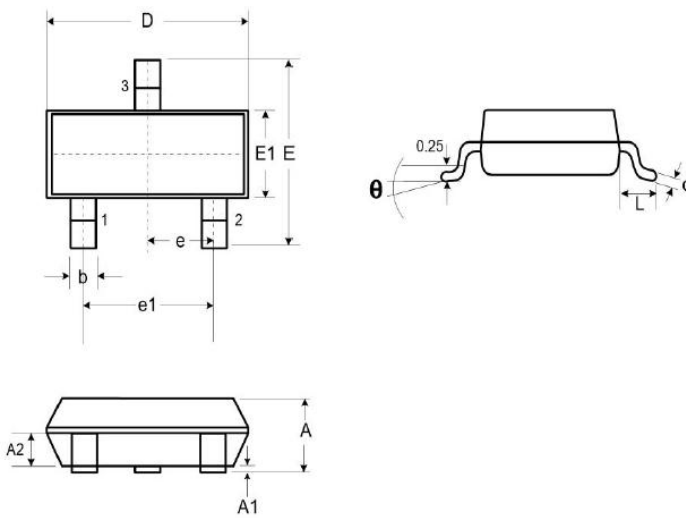

DIM	Millimeters		
	Min.	Typ.	Max.
A	0.89	-	1.12
A1	0.01	-	0.10
A2	0.88	0.95	1.02
b	0.30	-	0.51
c	0.08	-	0.18
D	2.80	2.90	3.04
E	2.10	2.37	2.64
E1	1.20	1.30	1.40
e	0.95		
e1	1.90		
L	0.40	0.50	0.60
L1	0.55		
N	3		
θ	0°	-	8°

Recommended Pad outline (Unit: mm)

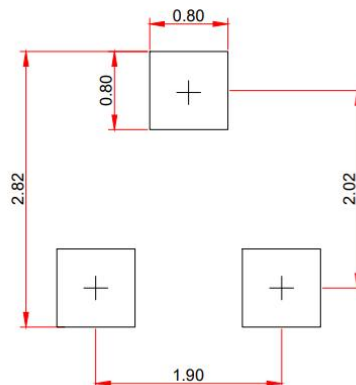



DISCLAIMER

SSCSEMI RESERVES THE RIGHT TO MAKE CHANGES WITHOUT FURTHER NOTICE TO ANY PRODUCTS HEREIN TO IMPROVE RELIABILITY, FUNCTION OR DESIGN. SSCSEMI DOES NOT ASSUME ANY LIABILITY ARISING OUT OF THE APPLICATION OR USE OF ANY PRODUCT OR CIRCUIT DESCRIBED HEREIN; NEITHER DOES IT CONVEY ANY LICIENCE UNDER ITS PATENT RIGHTS, NOR THE RIGHTS OF OTHERS.

THE GRAPHS PROVIDED IN THIS DOCUMENT ARE STATISTICAL SUMMARIES BASED ON A LIMITED NUMBER OF SAMPLES AND ARE PROVIDED FOR INFORMATIONAL PURPOSE ONLY. THE PERFORMANCE CHARACTERISTICS LISTED IN THEM ARE NOT TESTED OR GUARANTEED. IN SOME GRAPHS, THE DATA PRESENTED MAY BE OUTSIDE THE SPECIFIED OPERATING RANGE (E.G. OUTSIDE SPECIFIED POWER SUPPLY RANGE) AND THEREFORE OUTSIDE THE WARRANTED RANGE.

OUR PRODUCT SPECIFICATIONS ARE ONLY VALID IF OBTAINED THROUGH THE COMPANY'S OFFICIAL WEBSITE, CRM SYSTEM, OR OUR SALES PERSONNEL CHANNELS. IF CHANGES OR SPECIAL VERSIONS ARE INVOLVED, THEY MUST BE STAMPED WITH A QUALITY SEAL AND MARKED WITH A SPECIAL VERSION NUMBER TO BE VALID.