



SSC8122GS6

N-Channel Enhancement Mode MOSFET

Features

V _{DS}	V _{GS}	R _{DS(ON)} Typ.	I _D	ESD
20V	±8V	220mΩ@4V5	1.5A	2K
		300mΩ@2V5		
		460mΩ@1V8		

Description

This device is a N-Channel enhancement mode MOSFET which is produced with high cell density and DMOS trench technology. This device particularly suits low voltage applications, especially for battery powered circuits, the tiny and thin outline saves PCB consumption.

Applications

- Replace Digital Transistor
- Battery Operated Systems
- Power Supply Converter Circuits
- Load/Power Switching Cell Phones

Ordering Information

Device	Package	Shipping
SSC8122GS6	SOT-23	3000/Reel

Pin configuration

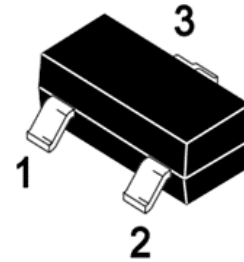

SOT-23

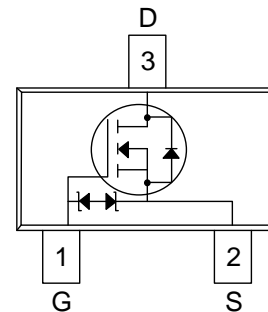

Pin Configuration (Top View)

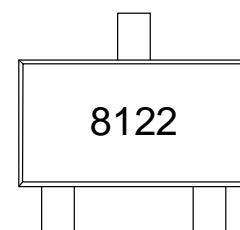

Marking



➤ **Absolute Maximum Ratings ($T_A=25^\circ\text{C}$ unless otherwise noted)**

Symbol	Parameter	Ratings	Unit
V_{DSS}	Drain-to-Source Voltage	20	V
V_{GSS}	Gate-to-Source Voltage	± 8	V
I_D	Continuous Drain Current ^a	1.5	A
I_{DM}	Pulsed Drain Current ^b	6	A
P_D	Power Dissipation ^c	0.86	W
T_J	Operation junction temperature	-55~150	$^\circ\text{C}$
T_{STG}	Storage temperature range	-55~150	$^\circ\text{C}$

➤ **Thermal Resistance Ratings ($T_A=25^\circ\text{C}$ unless otherwise noted)**

Symbol	Parameter	Maximum	Unit
$R_{\theta JA}$	Junction-to-Ambient Thermal Resistance ^a	145	$^\circ\text{C}/\text{W}$

Note:

- The value of $R_{\theta JA}$ is measured with the device mounted on 1 in² FR-4 board with 2oz.copper, in a still air environment with $T_A=25^\circ\text{C}$. The value in any given application depends on the user is specific board design. The power dissipation is based on the $t \leq 10\text{s}$ thermal resistance rating.
- Repetitive rating, pulse width limited by junction temperature.
- The power dissipation P_D is based on $T_{J(\text{MAX})}=150^\circ\text{C}$, using junction-to-case thermal resistance, and is more useful in setting the upper dissipation limit for cases where additional heat sinking is used.



➤ **Electrical Characteristics (T_A=25°C unless otherwise noted)**

Parameter	Symbol	Test Conditions	Min.	Typ.	Max.	Unit
Drain-Source Breakdown Voltage	V _{(BR)DSS}	V _{GS} = 0V, I _D = 250μA	20			V
Gate Threshold Voltage	V _{GS(th)}	V _{DS} = V _{GS} , I _D = 250uA	0.5	0.8	1.2	V
Drain-Source On-Resistance	R _{DS(on)}	V _{GS} = 4.5V, I _D = 0.5A		220	400	mΩ
		V _{GS} = 2.5V, I _D = 0.5A		300	500	
		V _{GS} = 1.8V, I _D = 0.35A		460	800	
Zero Gate Voltage Drain Current	I _{DSS}	V _{DS} = 16V, V _{GS} = 0V			1	μA
Gate-Source Leak Current	I _{GSS}	V _{GS} = ±8V, V _{DS} = 0V			±10	μA
Transconductance	G _{FS}	V _{DS} = 5V, I _D = 0.45A		2		s
Forward Voltage	V _{SD}	V _{GS} = 0V, I _S = 0.5A		0.8	1.3	V
Input Capacitance	C _{ISS}	V _{DS} = 10V, V _{GS} = 0V, f = 1MHz		62		pF
Output Capacitance	C _{OSS}			17		
Reverse Transfer Capacitance	C _{RSS}			8		
Turn-on Delay Time	T _{D(ON)}	V _{GS} = 4.5V, R _L = 10Ω V _{DD} = 10V, R _G = 3Ω		22		ns
Rise Time	T _r			9		
Turn-off Delay Time	T _{D(OFF)}			36		
Fall Time	T _f			6.7		



➤ **Typical Performance Characteristics ($T_A=25^\circ\text{C}$ unless otherwise noted)**

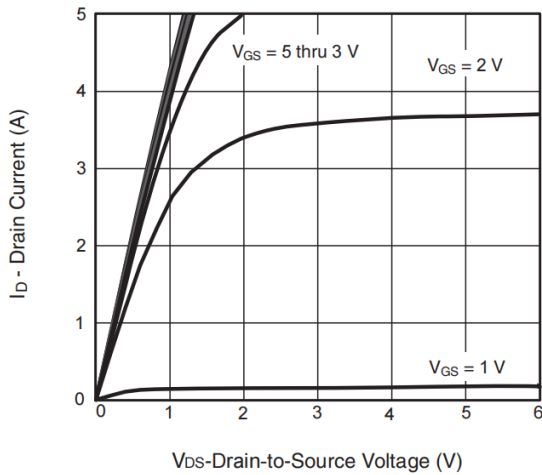

Output Characteristics

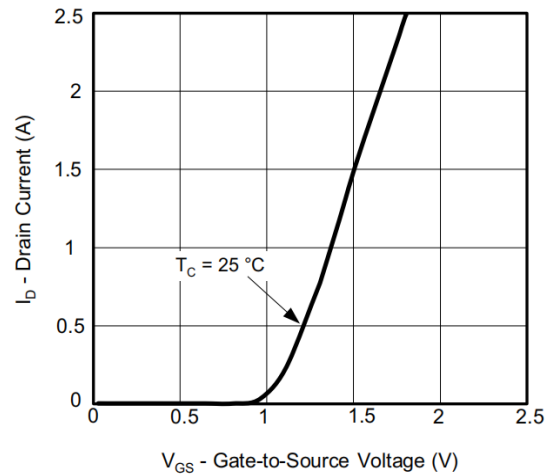

Transfer Characteristics

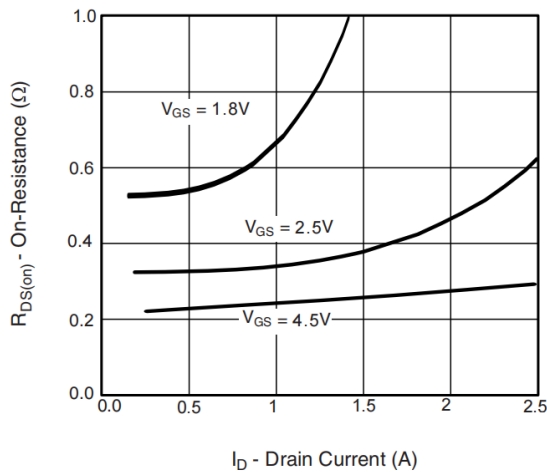

On-Resistance vs. Drain Current and Gate Voltage

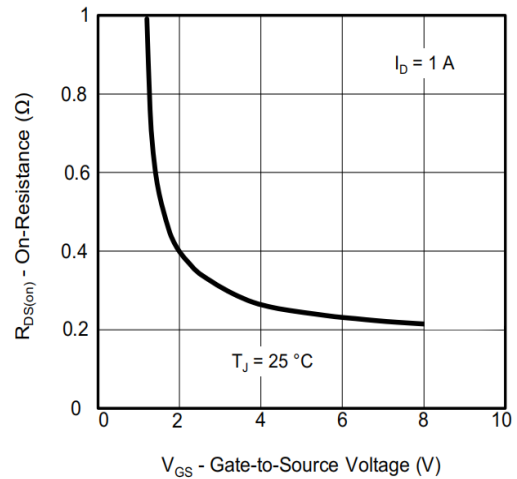

On-Resistance vs. Gate-to-Source Voltage

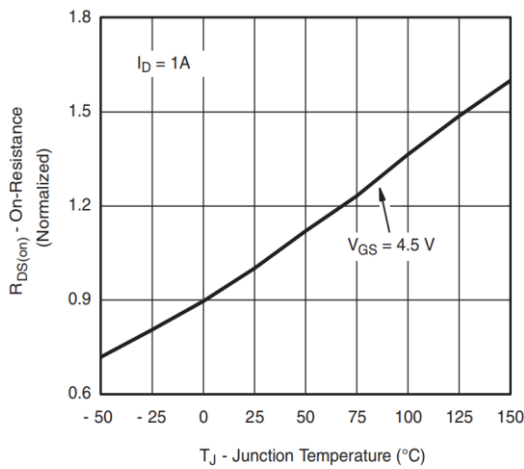

On-Resistance vs. Junction Temperature

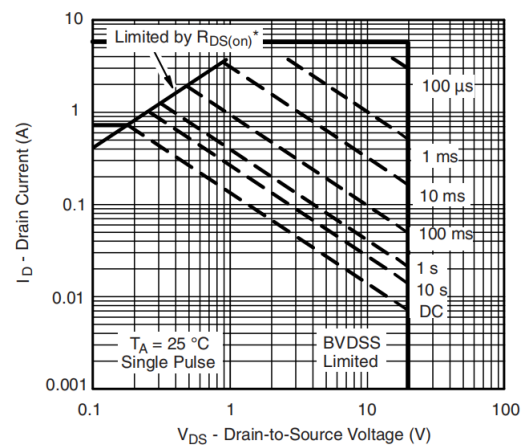

* $V_{GS} >$ minimum V_{GS} at which $R_{DS(on)}$ is specified

Safe Operating Area, Junction-to-Ambient

➤ Package Information

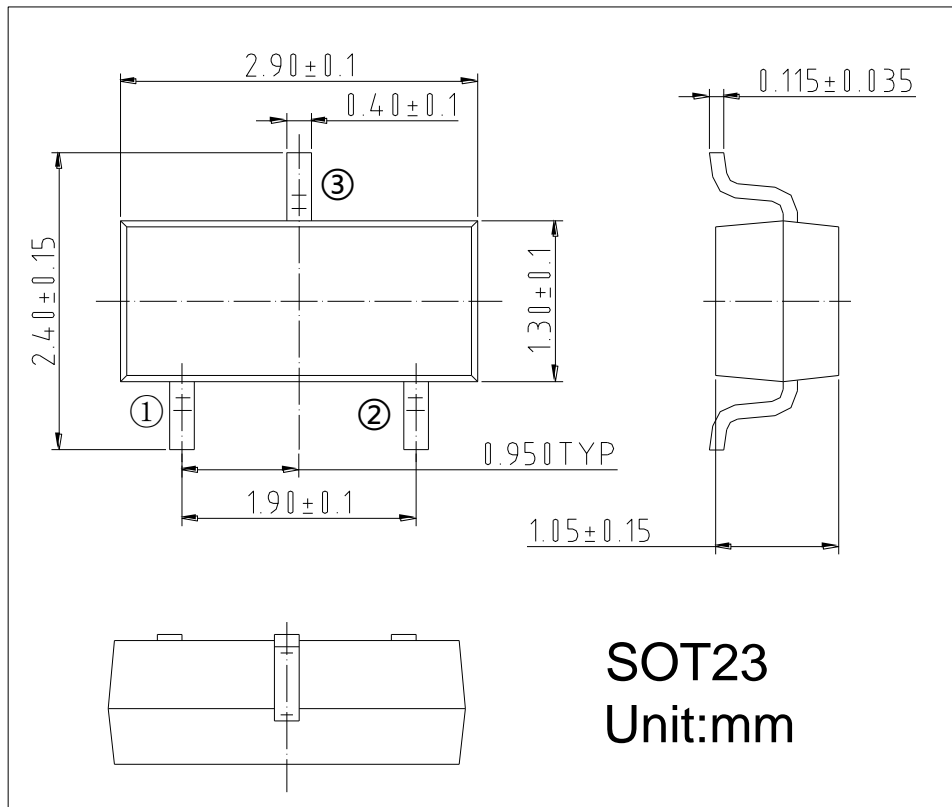

➤ Recommended Pad outline

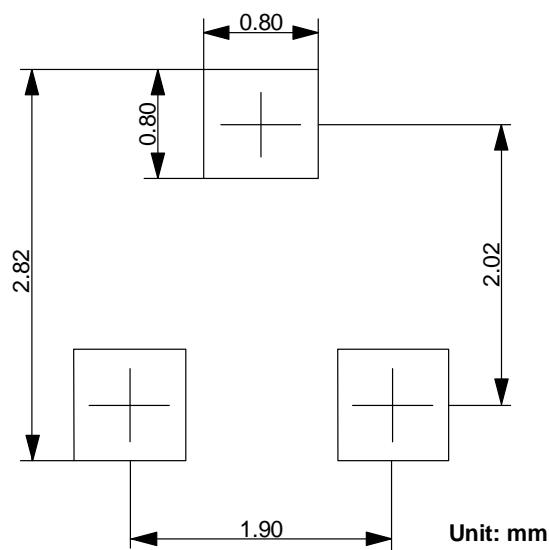



DISCLAIMER

SSCSEMI RESERVES THE RIGHT TO MAKE CHANGES WITHOUT FURTHER NOTICE TO ANY PRODUCTS HEREIN TO IMPROVE RELIABILITY, FUNCTION OR DESIGN. SSCSEMI DOES NOT ASSUME ANY LIABILITY ARISING OUT OF THE APPLICATION OR USE OF ANY PRODUCT OR CIRCUIT DESCRIBED HEREIN; NEITHER DOES IT CONVEY ANY LICIENCE UNDER ITS PATENT RIGHTS, NOR THE RIGHTS OF OTHERS.

THE GRAPHS PROVIDED IN THIS DOCUMENT ARE STATISTICAL SUMMARIES BASED ON A LIMITED NUMBER OF SAMPLES AND ARE PROVIDED FOR INFORMATIONAL PURPOSE ONLY. THE PERFORMANCE CHARACTERISTICS LISTED IN THEM ARE NOT TESTED OR GUARANTEED. IN SOME GRAPHS, THE DATA PRESENTED MAY BE OUTSIDE THE SPECIFIED OPERATING RANGE (E.G. OUTSIDE SPECIFIED POWER SUPPLY RANGE) AND THEREFORE OUTSIDE THE WARRANTED RANGE.

OUR PRODUCT SPECIFICATIONS ARE ONLY VALID IF OBTAINED THROUGH THE COMPANY'S OFFICIAL WEBSITE, CRM SYSTEM, OR OUR SALES PERSONNEL CHANNELS. IF CHANGES OR SPECIAL VERSIONS ARE INVOLVED, THEY MUST BE STAMPED WITH A QUALITY SEAL AND MARKED WITH A SPECIAL VERSION NUMBER TO BE VALID.