



SSC8030GS1

N-Channel Enhancement Mode MOSFET

➤ Features

VDS	VGS	RDSON Typ.	ID
30V	±20V	9mR@10V	13A
		11mR@4V5	

➤ Pin configuration

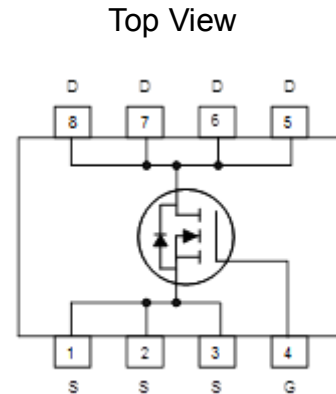

➤ Description

This device uses advanced trench technology to provide excellent RDSON and low gate charge. This device is suitable for use as a load switch or in PWM applications.

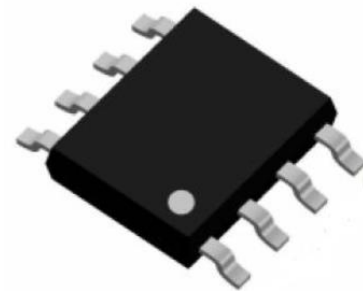

SOP8

➤ Applications

- Load Switch
- NB/PC
- DCDC conversion

➤ Ordering Information

Device	Package	Shipping
SSC8030GS1	SOP8	2500/Reel

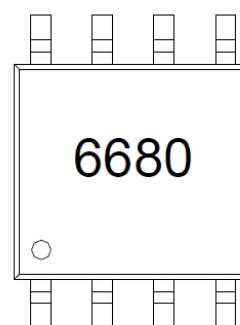

Marking



➤ **Absolute Maximum Ratings**($T_A=25^{\circ}\text{C}$ unless otherwise noted)

Symbol	Parameter	Ratings	Unit
V_{DS}	Drain-to-Source Voltage	30	V
V_{GS}	Gate-to-Source Voltage	± 20	V
I_D	Continuous Drain Current ^a	13	A
I_{DM}	Pulsed Drain Current ^b	51	A
P_D	Power Dissipation ^c	7.5	W
P_{DSM}	Power Dissipation ^a	3	W
T_J	Operation junction temperature	-55 to 150	$^{\circ}\text{C}$
T_{STG}	Storage temperature range	-55 to 150	$^{\circ}\text{C}$

➤ **Thermal Resistance Ratings**($T_A=25^{\circ}\text{C}$ unless otherwise noted)

Symbol	Parameter	Typical	Maximum	Unit
$R_{\theta JA}$	Junction-to-Ambient Thermal Resistance ^a		45	$^{\circ}\text{C}/\text{W}$
$R_{\theta JC}$	Junction-to-Case Thermal Resistance		20	

Note:

- The value of $R_{\theta JA}$ is measured with the device mounted on 1 in² FR-4 board with 2oz.copper,in a still air environment with $T_A=25^{\circ}\text{C}$.The value in any given application depends on the user is specific board design. The current rating is based on the $t \leq 10\text{s}$ thermal resistance rating.
- Repetitive rating, pulse width limited by junction temperature.
- The power dissipation P_D is based on $T_J(\text{MAX})=150^{\circ}\text{C}$, using junction-to-case thermal resistance, and is more useful in setting the upper dissipation limit for cases where additional heat sinking is used.



➤ **Electronics Characteristics**($T_A=25^{\circ}\text{C}$ unless otherwise noted)

Symbol	Parameter	Test Conditions	Min	Typ.	Max	Unit
$V_{(BR)DSS}$	Drain-Source Breakdown Voltage	$V_{GS}=0V, I_D=250\mu A$	30			V
$V_{GS(th)}$	Gate Threshold Voltage	$V_{DS}=V_{GS}, I_D=250\mu A$	1		3	V
$R_{DS(on)}$	Drain-Source On- Resistance	$V_{GS}=10V, I_D=15A$		9	11	mR
		$V_{GS}=4.5V, I_D=12A$		11	15	
I_{DSS}	Zero Gate Voltage Drain Current	$V_{DS}=24V, V_{GS}=0V$			1	μA
I_{GSS}	Gate-Source leak current	$V_{GS}=\pm 20V, V_{DS}=0V$			± 100	nA
G_{FS}	Transconductance	$V_{DS}=15V, I_D=12A$		46		S
V_{SD}	Forward Voltage	$V_{GS}=0V, I_S=1A$		0.8	1.5	V
C_{iss}	Input Capacitance	$V_{DS}=15V, V_{GS}=0V, f=1MHz$		1200		pF
C_{oss}	Output Capacitance			200		
C_{rss}	Reverse Transfer Capacitance			105		
$T_{D(ON)}$	Turn-on delay time	$V_{GS}=10V,$ $V_{DS}=15V, R_L=2.3R, R_G=3R$		18		ns
T_r	Rise time			6		
$T_{D(OFF)}$	Turn-off delay time			70		
T_f	Fall time			17		
Q_g	Total Gate charge	$V_{GS}=10V, V_{DS}=10V, I_D=14A$		20		nC
Q_{gs}	Gate to Source charge			3		
Q_{gd}	Gate to Drain charge			5		



➤ **Typical Characteristics** ($T_A=25^\circ\text{C}$ unless otherwise noted)

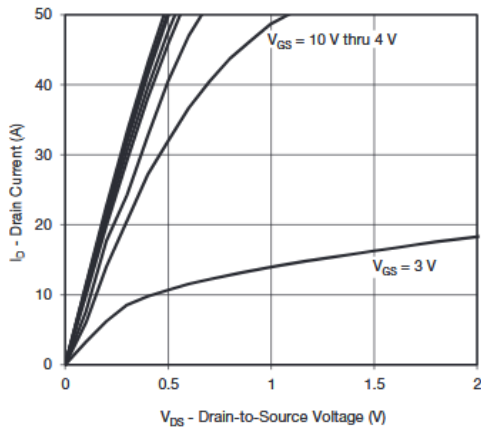

Output Characteristics

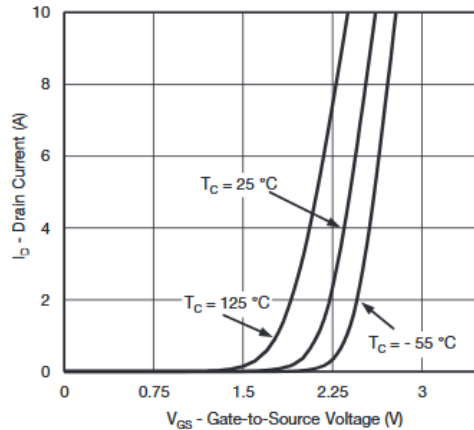

Transfer Characteristics

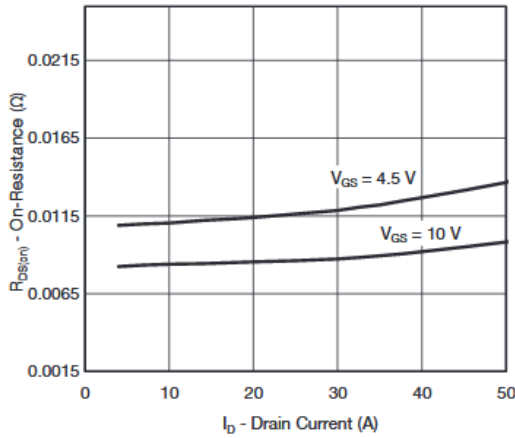

On-Resistance vs. Drain Current

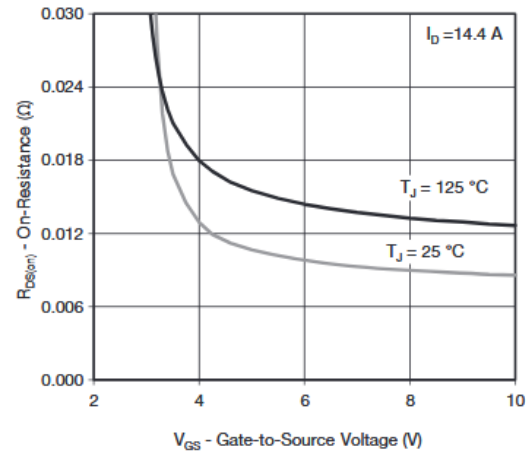

On-Resistance vs. Gate-to-Source Voltage

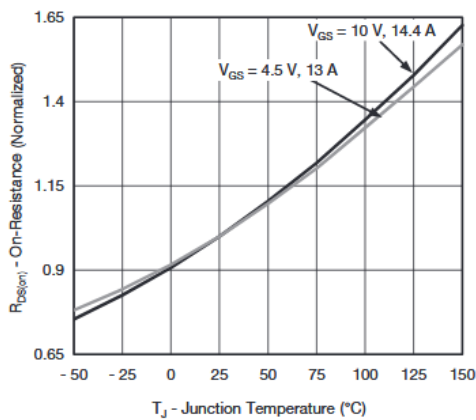

On-Resistance vs. Junction Temperature

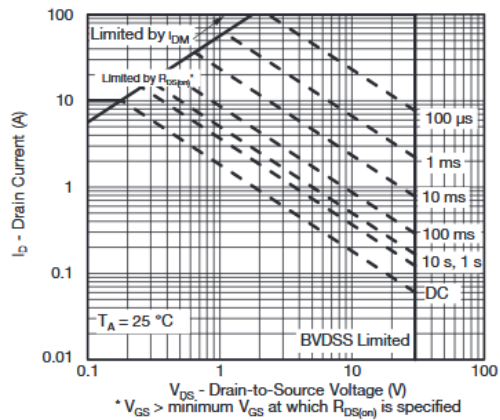

Safe Operating Area, Junction-to-Ambient



➤ Package Information

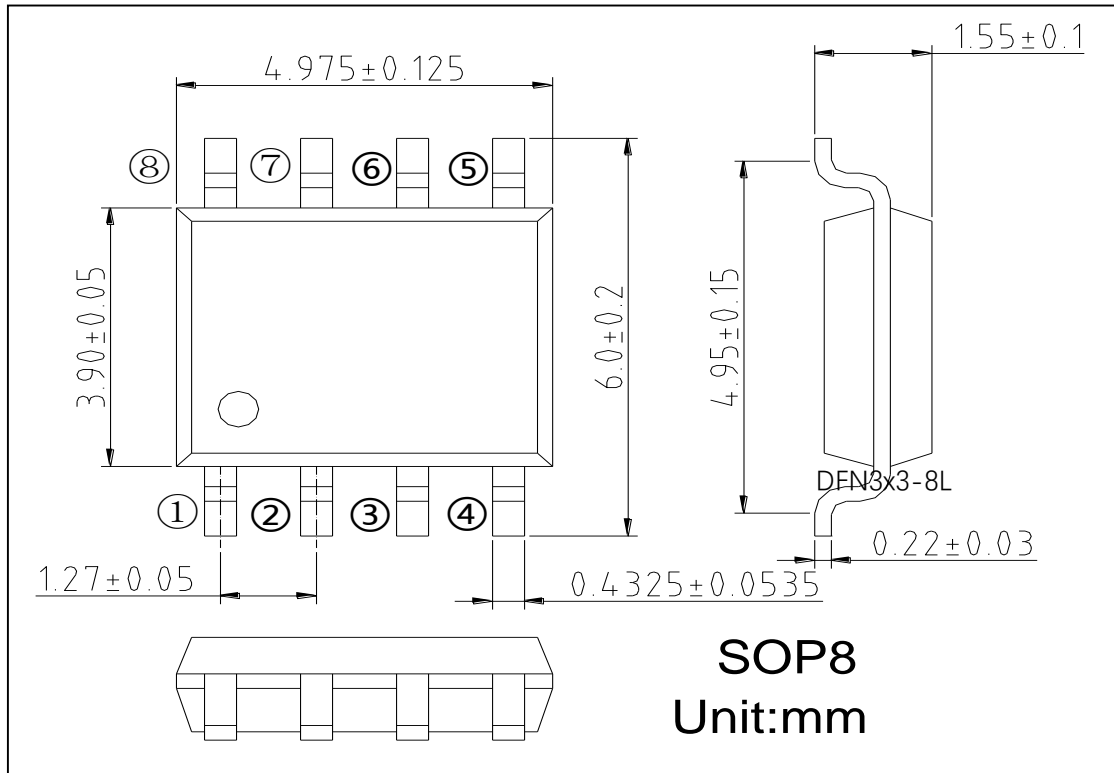

DISCLAIMER

AFSEMI RESERVES THE RIGHT TO MAKE CHANGES WITHOUT FURTHER NOTICE TO ANY PRODUCTS HEREIN TO IMPROVE RELIABILITY, FUNCTION OR DESIGN. AFSEMI DOES NOT ASSUME ANY LIABILITY ARISING OUT OF THE APPLICATION OR USE OF ANY PRODUCT OR CIRCUIT DESCRIBED HEREIN; NEITHER DOES IT CONVEY ANY LICIENCE UNDER ITS PATENT RIGHTS, NOR THE RIGHTS OF OTHERS.

THE GRAPHS PROVIDED IN THIS DOCUMENT ARE STATISTICAL SUMMARIES BASED ON A LIMITED NUMBER OF SAMPLES AND ARE PROVIDED FOR INFORMATIONAL PURPOSE ONLY. THE PERFORMANCE CHARACTERISTICS LISTED IN THEM ARE NOT TESTED OR GUARANTEED. IN SOME GRAPHS, THE DATA PRESENTED MAY BE OUTSIDE THE SPECIFIED OPERATING RANGE (E.G. OUTSIDE SPECIFIED POWER SUPPLY RANGE) AND THEREFORE OUTSIDE THE WARRANTED RANGE.