



SSC8164GS8

N-Channel Small Switching MOSFET with ESD Protection

➤ **Features**

VDS	VGS	RDSON Typ.	ID	ESD
60V	±20V	1R@10V	0.4A	500V
		1.5R@4V5		

➤ **Pin configuration**

Top view

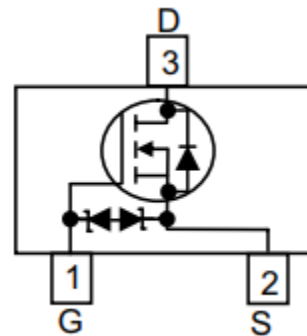

➤ **Description**

This device is an N-Channel enhancement mode MOSFET, with low on-resistance, fast switching speed and low threshold voltage, it is ideal for portable equipment.

➤ **Applications**

- Direct Logic-Level Interface: TTL/CMOS
- Drivers: Relays, Solenoids, Lamps, Hammers
- Display, Memories, Transistors, etc.
- Battery Operated System
- Solid-State Relays

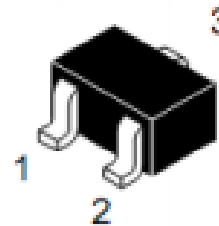

SOT523

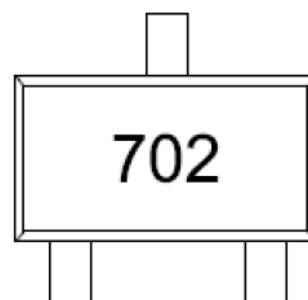

Marking

➤ **Ordering Information**

Device	Package	Shipping
SSC8164GS8	SOT523	3000/Reel



➤ **Absolute Maximum Ratings**($T_A=25^{\circ}\text{C}$ unless otherwise noted)

Symbol	Parameter	Ratings	Unit
V_{DSS}	Drain-to-Source Voltage	60	V
V_{GSS}	Gate-to-Source Voltage	± 20	V
I_D	Continuous Drain Current ^a	0.4	A
I_{DM}	Pulsed Drain Current ^b	1	A
P_D	Power Dissipation ^c	0.8	W
P_{DSM}	Power Dissipation ^a	0.3	W
T_J	Operation junction temperature	-55 to 150	$^{\circ}\text{C}$
T_{STG}	Storage temperature range	-55 to 150	$^{\circ}\text{C}$

➤ **Thermal Resistance Ratings**($T_A=25^{\circ}\text{C}$ unless otherwise noted)

Symbol	Parameter	Typical	Maximum	Unit
$R_{\theta JA}$	Junction-to-Ambient Thermal Resistance ^a		430	$^{\circ}\text{C}/\text{W}$
$R_{\theta JC}$	Junction-to-Case Thermal Resistance		160	

Note:

- The value of $R_{\theta JA}$ is measured with the device mounted on 1 in² FR-4 board with 2oz.copper, in a still air environment with $T_A=25^{\circ}\text{C}$. The value in any given application depends on the user is specific board design. The current rating is based on the $t \leq 10\text{s}$ thermal resistance rating.
- Repetitive rating, pulse width limited by junction temperature.
- The power dissipation P_D is based on $T_{J(MAX)}=150^{\circ}\text{C}$, using junction-to-case thermal resistance, and is more useful in setting the upper dissipation limit for cases where additional heat sinking is used.



➤ **Electronics Characteristics**($T_A=25^{\circ}\text{C}$ unless otherwise noted)

Symbol	Parameter	Test Conditions	Min	Typ.	Max	Unit
$V_{(BR)DSS}$	Drain-Source Breakdown Voltage	$V_{GS}=0V, I_D=10\mu A$	60			V
$V_{GS(th)}$	Gate Threshold Voltage	$V_{DS}=V_{GS}, I_D=250\mu A$	0.75	1	1.25	V
$R_{DS(on)}$	Drain-Source On- Resistance	$V_{GS}=10V, I_D=0.5A$		1	2.5	R
		$V_{GS}=4.5V, I_D=0.5A$		1.5	3.5	
		$V_{GS}=2.5V, I_D=0.2A$		2.8	4	
I_{DSS}	Zero Gate Voltage Drain Current	$V_{DS}=60V, V_{GS}=0V$			1	μA
I_{GSS}	Gate-Source leak current	$V_{GS}=\pm 15V, V_{DS}=0V$			± 10	μA
G_{FS}	Transconductance	$V_{DS}=10V, I_D=0.2A$		0.1		S
V_{SD}	Forward Voltage	$V_{GS}=0V, I_S=0.2A$			1.3	V
C_{iss}	Input Capacitance	$V_{DS}=25V, V_{GS}=0V, f=1MHz$		30		pF
C_{oss}	Output Capacitance			6		
C_{rss}	Reverse Transfer Capacitance			2.9		
$T_{D(ON)}$	Turn-on delay time		$V_{GS}=10V,$ $V_{DS}=10V, I_D=100mA$		25	
T_r	Rise Time			10		
$T_{D(OFF)}$	Turn-off delay time			35		
T_f	Fall Time			20		
Q_G	Total Gate Charge	$V_{GS}=10V, V_{DS}=15V, I_D=0.2A$		0.4		nC
Q_{GS}	Gate Source Charge			0.1		
Q_{GD}	Gate Drain Charge			0.11		



➤ **Typical Characteristics** ($T_A=25^\circ\text{C}$ unless otherwise noted)

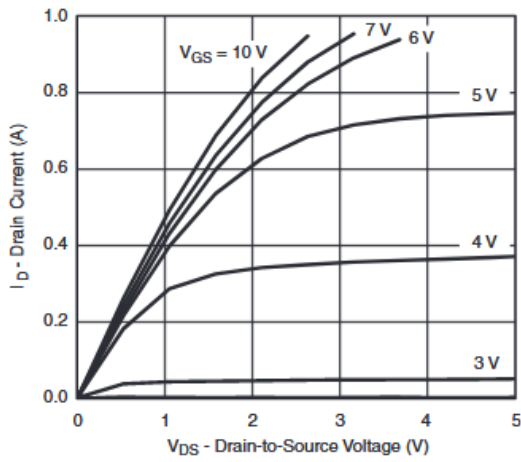

Output Characteristics

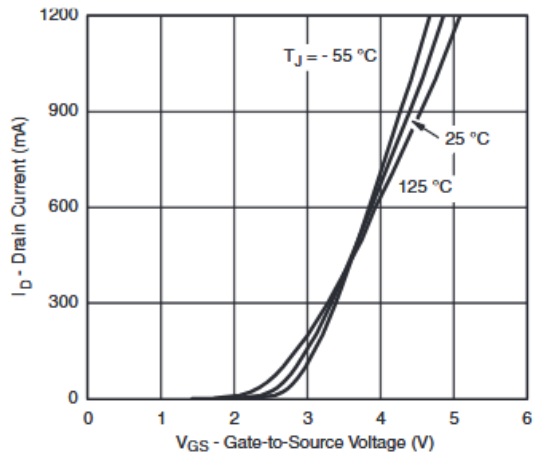

Transfer Characteristics

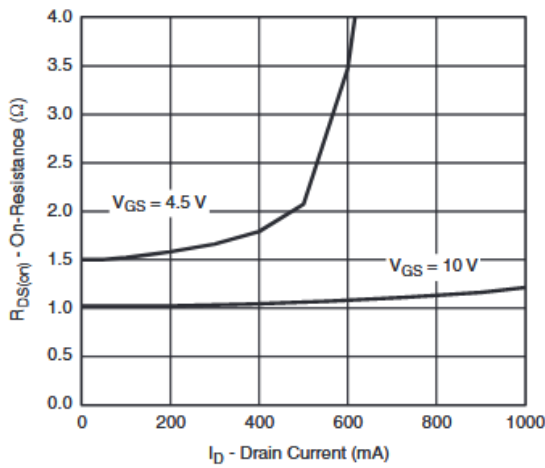

On-Resistance vs. Drain Current

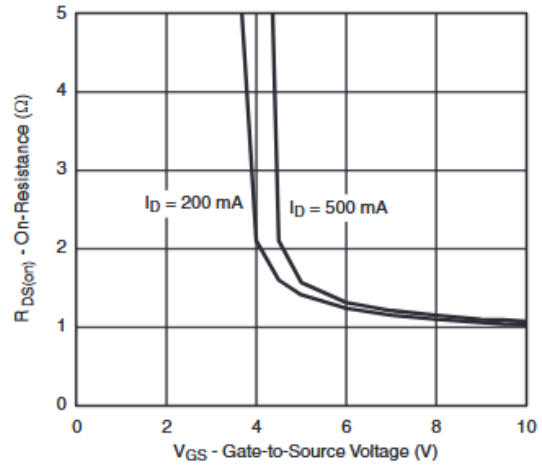

On-Resistance vs. Gate-Source Voltage

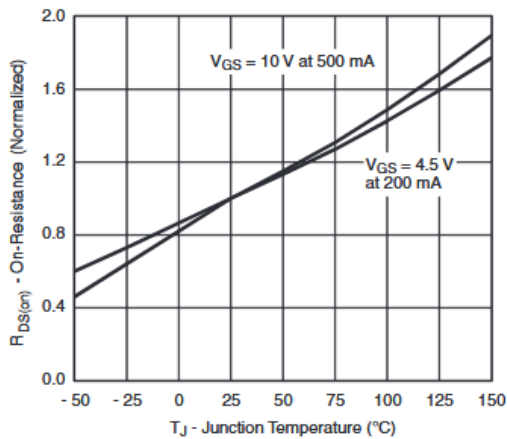

On-Resistance vs. Junction Temperature

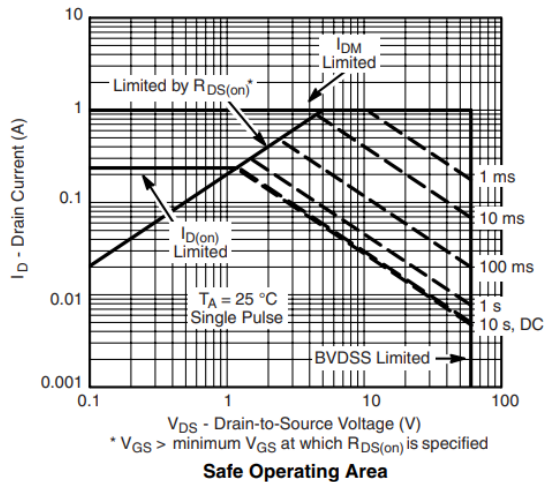

Safe Operating Area

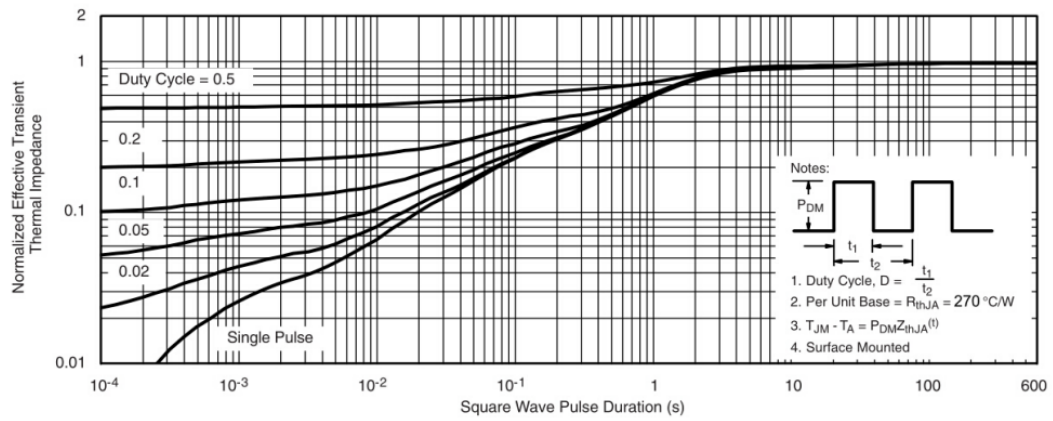

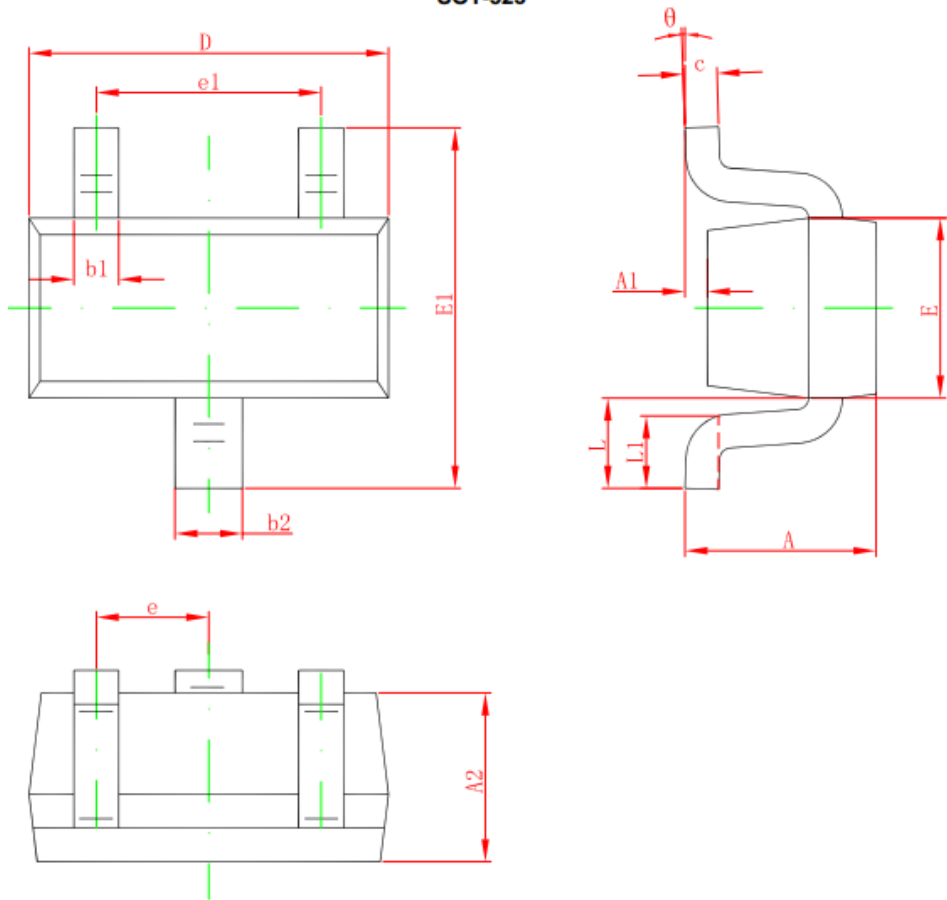
➤ Package Information
SOT-523

Symbol	Dimension in Millimeters	
	Min.	Max.
A	0.700	0.900
A1	0.000	0.100
A2	0.700	0.800
b1	0.150	0.250
b2	0.250	0.350
c	0.100	0.200
D	1.500	1.700
E	0.700	0.900
E1	1.450	1.750
e	0.500 Typ.	
e1	0.900	1.100
L	0.400 Ref.	
L1	0.260	0.460
θ	0°	8°



DISCLAIMER

AFSEMI RESERVES THE RIGHT TO MAKE CHANGES WITHOUT FURTHER NOTICE TO ANY PRODUCTS HEREIN TO IMPROVE RELIABILITY, FUNCTION OR DESIGN. AFSEMI DOES NOT ASSUME ANY LIABILITY ARISING OUT OF THE APPLICATION OR USE OF ANY PRODUCT OR CIRCUIT DESCRIBED HEREIN; NEITHER DOES IT CONVEY ANY LICENCE UNDER ITS PATENT RIGHTS, NOR THE RIGHTS OF OTHERS.

THE GRAPHS PROVIDED IN THIS DOCUMENT ARE STATISTICAL SUMMARIES BASED ON A LIMITED NUMBER OF SAMPLES AND ARE PROVIDED FOR INFORMATIONAL PURPOSE ONLY. THE PERFORMANCE CHARACTERISTICS LISTED IN THEM ARE NOT TESTED OR GUARANTEED. IN SOME GRAPHS, THE DATA PRESENTED MAY BE OUTSIDE THE SPECIFIED OPERATING RANGE (E.G. OUTSIDE SPECIFIED POWER SUPPLY RANGE) AND THEREFORE OUTSIDE THE WARRANTED RANGE.