

1A Bipolar Linear Regulator

➤ Features

- Maximum output current is 1A
- Input Voltage Range: 2.5V~18V
- Line regulation: 0.1%/V(typ.)
- Standby current: 2mA (typ.)
- Load regulation: 10mV(typ.)
- Environment Temperature: -20~85(C°)

➤ General Description

AF1117A is a series of low dropout voltage, three-terminal regulators. Its application circuit is very simple: the fixed version only needs two capacitors and the adjustable version only needs two resistors and two capacitors to work. Other than a fixed version, $V_{out}=1.2V, 1.8V, 2.5V, 3.3V, 5V$ and $12V$, AF1117A has an adjustable version, which can provide an output voltage from 1.25V to 5.0V with only two external resistors. The output voltage of adjustable version follows the equation: $V_{out}=1.25 \times (1+R2/R1) + I_{adj} \times R2$. We can ignore I_{adj} because I_{adj} (about 50uA) is much less than the current of $R1$ (about 2~10mA). To meet the minimum load current (>10mA) requirement, $R1$ is recommended to be 125ohm or lower. As AF1117A-ADJ can keep itself stable at load current about 2mA, $R1$ is not allowed to be higher than 625ohm.

AF1117A offers thermal shut down and current limit functions, to assure the stability of chip and power system. And it uses trimming technique to guarantee output voltage accuracy within 2%. Other output voltage accuracy can be customized on demand, such as 1%.

AF1117A is available in SOT-223 and SOT-89-3L power package.

The moisture sensitivity level is currently up to MSL3.

➤ Typical Applications

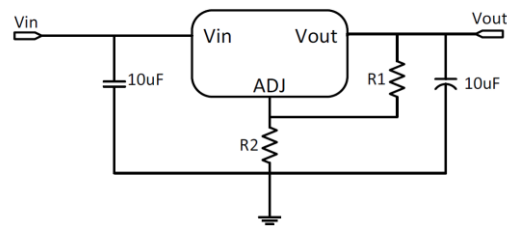
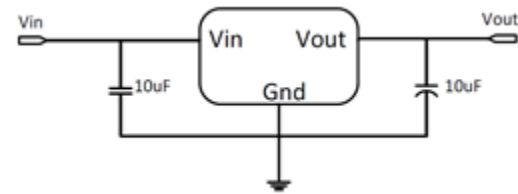

➤ Ordering Information

| | | |
|----------------|-----------|------------|
| <u>AF1117A</u> | <u>XX</u> | <u>L/P</u> |
| ① | ② | ③ |

Notes :

- ① : Product code
- ② : Output Voltage
33 : 3.3V
- ③ : Package
L : SOT-223
P : SOT-89-3L

| Package | Packing | Shipping |
|-----------|----------|-----------|
| SOT-223 | Tape and | 2.5K/Reel |
| SOT-89-3L | Reel | 1K/Reel |

➤ Applications

- Power management for Computer Mother Board, Graphic Card
- LCD Monitor and LCD TV
- DVD Decode Board
- ADSL Modem
- Post Regulators for Switching Supplies

➤ **Pin Configuration**

SOT-223

Top View

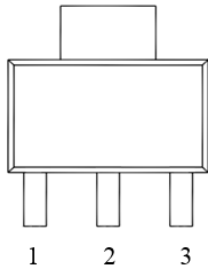

1.Vss/Adj 2.Vout 3.Vin
Marking

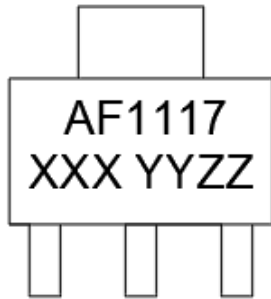

Marking Notes :

AF1117 : Product code

XXX : Output Voltage

3V3 : 3.3V

ADJ : adjustable

YY : Year

18 : 2018

ZZ : Week

05 : Fifth week

Bottom view

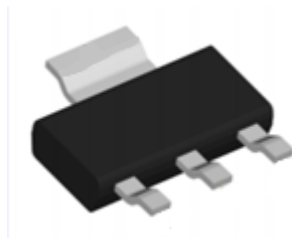

SOT-89-3

Top View

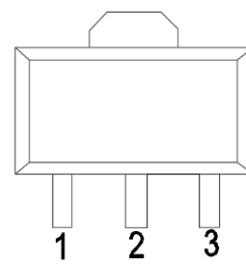

1.GND 2.Vout 3.Vin
Marking

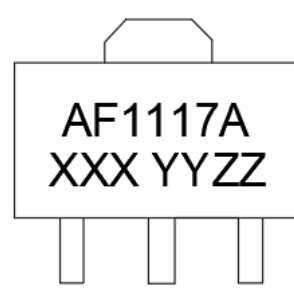

Marking Notes :

AF1117A : Product code

XXX : Output Voltage

3V3 : 3.3V

ADJ : adjustable

YY : Year

18 : 2018

ZZ : Week

05 : Fifth week

Bottom view

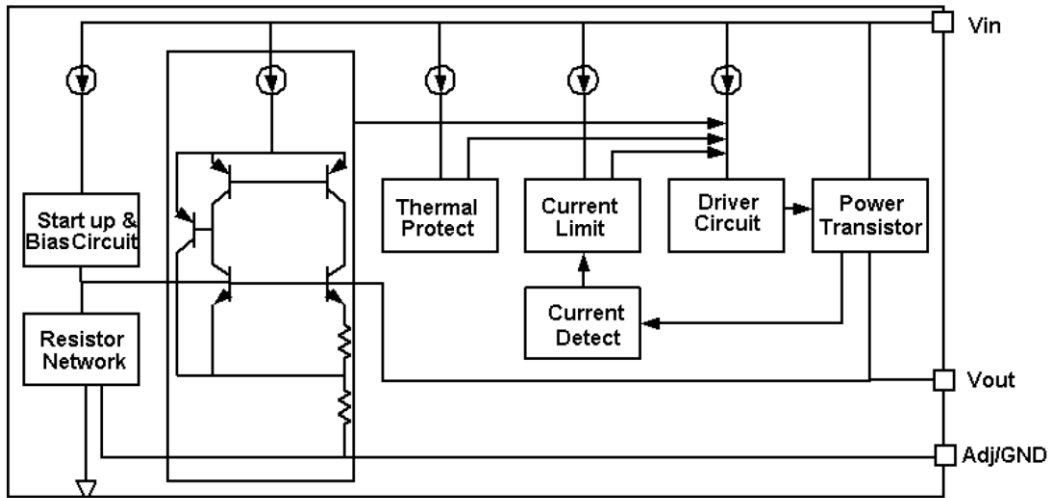

➤ **Block Diagram**

 ➤ **Thermal Information**

| Package Thermal Resistance | Rating | Unit |
|----------------------------|--------|------|
| SOT-223 | 20 | C°/W |
| SOT-89 | 30 | |

 ➤ **Absolute Maximum Rating**

| Parameter | Value |
|------------------------------------|-------------|
| Max Input Voltage | 18V |
| Max Power Dissipation | 1.2W |
| Max Output Current | 1A |
| Max Operating Junction Temperature | 150C° |
| Ambient Temperature | -40C°~85C° |
| Storage Temperature | -40C°~150C° |
| Lead Temperature & Time | 260C°,10s |

➤ Electrical Characteristics

| Symbol | Parameter | Conditions | Min | Typ | Max | Unit |
|-------------------|-------------------|-----------------------------------------------------------------------|-------|------|-------|------|
| Vref | Reference voltage | AF1117A-ADJ 10mA ≤ I _{out} ≤ 1A, V _{in} = 3.25V | 1.225 | 1.25 | 1.275 | V |
| V _{out} | Output Voltage | AF1117A-1.2V 0 ≤ I _{out} ≤ 1A, V _{in} = 3.2V | 1.176 | 1.2 | 1.224 | V |
| | | AF1117A-1.8V 0 ≤ I _{out} ≤ 1A, V _{in} = 3.8V | 1.76 | 1.8 | 1.836 | |
| | | AF1117A-2.5V 0 ≤ I _{out} ≤ 1A, V _{in} = 4.5V | 2.45 | 2.5 | 2.55 | |
| | | AF1117A-3.3V 0 ≤ I _{out} ≤ 1A, V _{in} = 5.3V | 3.234 | 3.3 | 3.366 | |
| | | AF1117A-5.0V 0 ≤ I _{out} ≤ 1A, V _{in} = 7.0V | 4.9 | 5 | 5.1 | |
| | | AF1117A-12.0V 0 ≤ I _{out} ≤ 1A, V _{in} = 14V | 11.76 | 12 | 12.24 | |
| ΔV _{out} | Line Regulation | AF1117A-ADJ I _{out} = 10mA, 2.75V ≤ V _{in} ≤ 12V | | 0.1 | 0.4 | %V |
| | | AF1117A-1.2V I _{out} = 10mA, 2.7V ≤ V _{in} ≤ 10V | | 0.1 | 0.4 | |
| | | AF1117A-1.8V I _{out} = 10mA, 3.3V ≤ V _{in} ≤ 12V | | 0.1 | 0.4 | |
| | | AF1117A-2.5V I _{out} = 10mA, 4.0V ≤ V _{in} ≤ 12V | | 0.1 | 0.4 | |
| | | AF1117A-3.3V I _{out} = 10mA, 4.8V ≤ V _{in} ≤ 12V | | 0.1 | 0.4 | |
| | | AF1117A-5.0V I _{out} = 10mA, 6.5V ≤ V _{in} ≤ 12V | | 0.1 | 0.4 | |
| V _{drop} | Dropout voltage | I _{out} = 100mA | | 1.23 | 1.3 | V |
| | | I _{out} = 1A | | 1.3 | 1.5 | V |
| ΔV _{out} | Load Regulation | AF1117A-ADJ V _{in} = 2.75V, 10mA ≤ I _{out} ≤ 1A | | 10 | 32 | mV |
| | | AF1117A-1.2V V _{in} = 2.7V, 10mA ≤ I _{out} ≤ 1A | | 10 | 32 | |
| | | AF1117A-1.8V V _{in} = 3.3V, 10mA ≤ I _{out} ≤ 1A | | 10 | 32 | |
| | | AF1117A-2.5V V _{in} = 4.0V, 10mA ≤ I _{out} ≤ 1A | | 10 | 32 | |
| | | AF1117A-3.3V V _{in} = 4.8V, 10mA ≤ I _{out} ≤ 1A | | 10 | 32 | |
| | | AF1117A-5.0V V _{in} = 6.5V, 10mA ≤ I _{out} ≤ 1A | | 10 | 32 | |



AF1117A

| | | | | | | |
|---------|------------------------------|-----------------------------------------|-----|------|-----|--------|
| | | AF1117A-12.0V Vin=13.5V,10mA≤Iout≤1A | | 10 | 32 | |
| IQ | Quiescent Current | AF1117A-ADJ,Vin=12V | | 2 | 5 | mA |
| | | AF1117A-1.2V,Vin=10V | | 2 | 5 | |
| | | AF1117A-1.8V,Vin=12V | | 2 | 5 | |
| | | AF1117A-2.5V,Vin=12V | | 2 | 5 | |
| | | AF1117A-3.3V,Vin=12V | | 2 | 5 | |
| | | AF1117A-5.0V,Vin=12V | | 2 | 5 | |
| | | AF1117A-12.0V,Vin=20V | | 2 | 5 | |
| PSRR | Power Supply Rejection Ratio | f=100Hz, Cout=104 | | -65 | | dB |
| | | f=1KHz, Cout=104 | | -65 | | |
| | | f=10KHz, Cout=104 | | -60 | | |
| | | f=22KHz, Cout=104 | | -70 | | |
| Iadj | Adjust pin current | AF1117A-ADJ Vin=5V,10mA≤Iout≤1A | | 55 | 120 | uA |
| Ichange | Change current | AF1117A-ADJ Vin=5V,10mA≤Iout≤1A | | 0.2 | 10 | uA |
| Ilim | Output Limit Current | Vin-Vout=2V | 0.8 | | | A |
| Imin | Minimum load current | AF1117A-ADJ | 2 | 10 | | mA |
| ΔV/ΔT | Temperature Coefficient | Iout =40mA | | ±100 | | ppm/C° |

➤ Typical Performance Characteristics

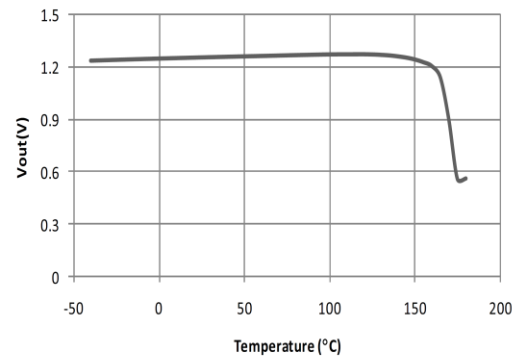
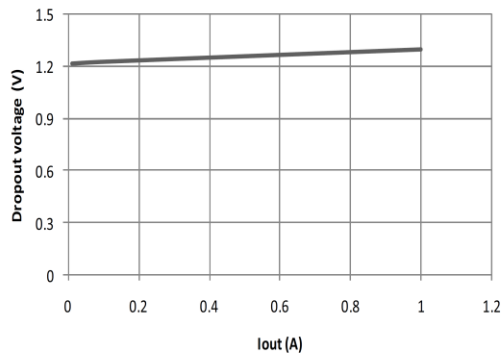
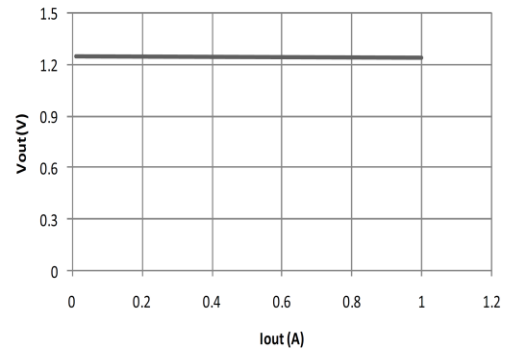
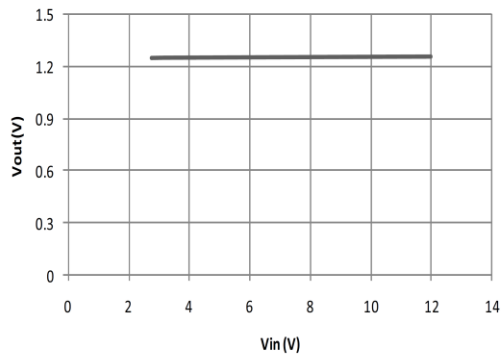

➤ Package Information

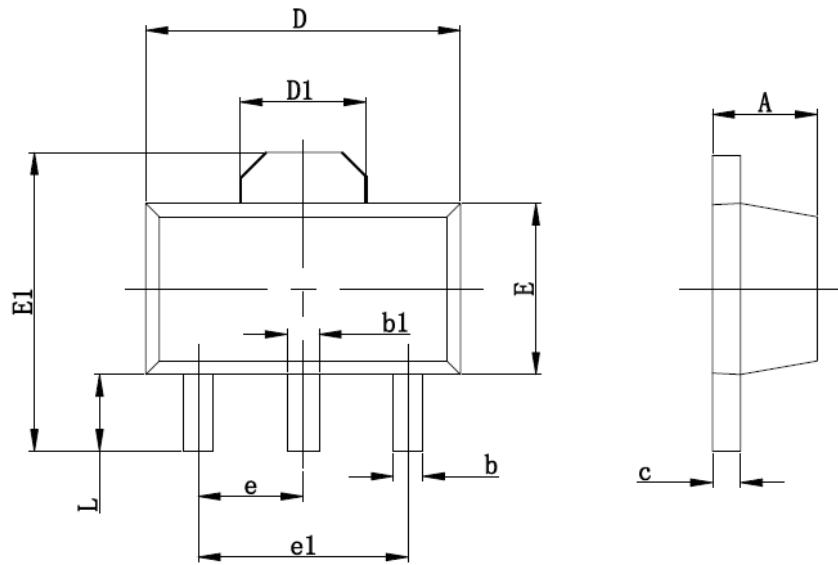

| Symbol | Dimensions In Millimeters | | Dimensions In Inches | |
|--------|---------------------------|-------|----------------------|-------|
| | Min | Max | Min | Max |
| A | 1.400 | 1.600 | 0.055 | 0.063 |
| b | 0.350 | 0.520 | 0.013 | 0.197 |
| b1 | 0.400 | 0.580 | 0.016 | 0.023 |
| c | 0.350 | 0.440 | 0.014 | 0.017 |
| D | 4.400 | 4.600 | 0.173 | 0.181 |
| D1 | 1.550 REF | | 0.061 REF | |
| E | 2.350 | 2.550 | 0.091 | 0.102 |
| E1 | 3.940 | 4.250 | 0.155 | 0.167 |
| e | 1.500 TYP | | 0.060TYP | |
| e1 | 3.000 TYP | | 0.118TYP | |
| L | 0.900 | 1.100 | 0.035 | 0.047 |

SOT-89-3

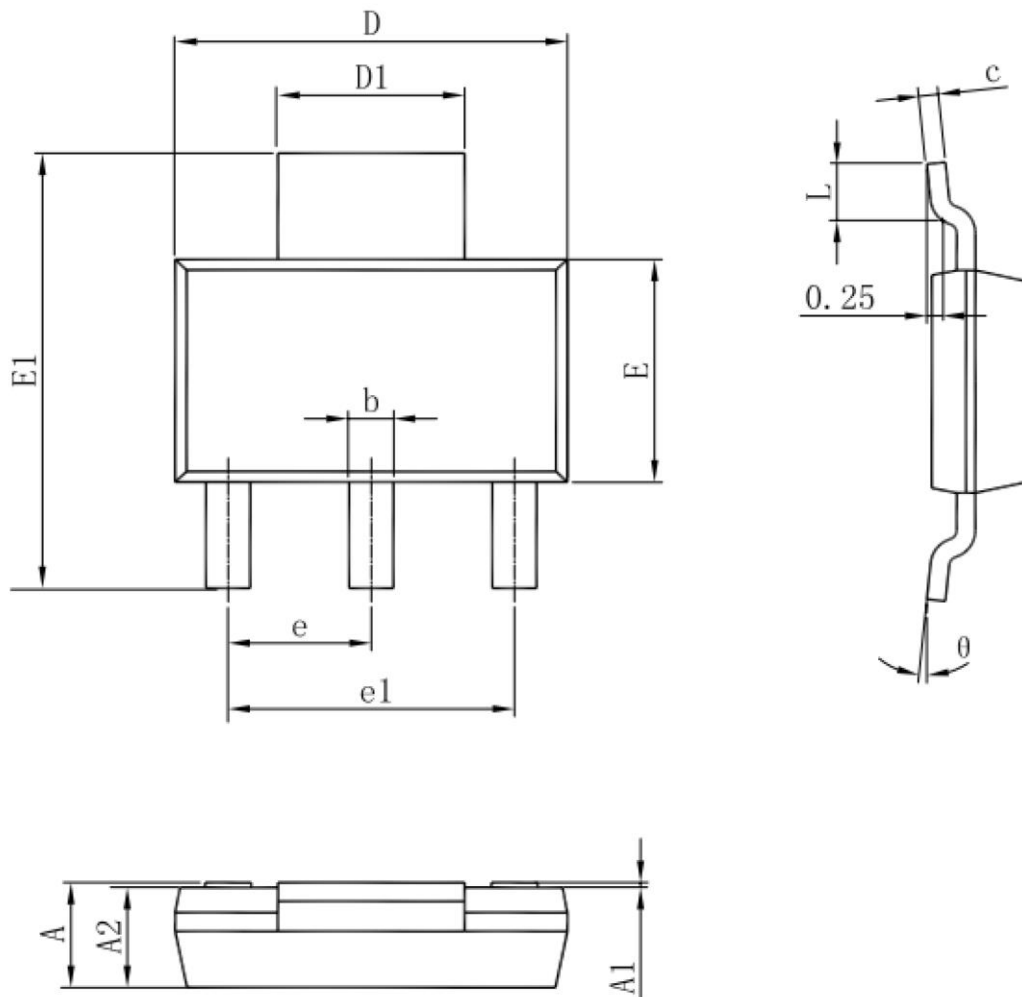

| Symbol | Dimensions In Millimeters | | Dimensions In Inches | |
|----------|---------------------------|-------|----------------------|-------|
| | Min | Max | Min | Max |
| A | 1.520 | 1.800 | 0.060 | 0.071 |
| A1 | 0.000 | 0.100 | 0.000 | 0.004 |
| A2 | 1.500 | 1.700 | 0.059 | 0.067 |
| b | 0.660 | 0.820 | 0.026 | 0.032 |
| c | 0.250 | 0.350 | 0.010 | 0.014 |
| D | 6.200 | 6.400 | 0.244 | 0.252 |
| D1 | 2.900 | 3.100 | 0.114 | 0.122 |
| E | 3.300 | 3.700 | 0.130 | 0.146 |
| E1 | 6.830 | 7.070 | 0.269 | 0.278 |
| e | 2.300(BSC) | | 0.091(BSC) | |
| e1 | 4.500 | 4.700 | 0.177 | 0.185 |
| L | 0.900 | 1.150 | 0.035 | 0.045 |
| θ | 0° | 10° | 0° | 10° |

SOT-223



DISCLAIMER

AFSEMI RESERVES THE RIGHT TO MAKE CHANGES WITHOUT FURTHER NOTICE TO ANY PRODUCTS HEREIN TO IMPROVE RELIABILITY, FUNCTION OR DESIGN. AFSEMI DOES NOT ASSUME ANY LIABILITY ARISING OUT OF THE APPLICATION OR USE OF ANY PRODUCT OR CIRCUIT DESCRIBED HEREIN; NEITHER DOES IT CONVEY ANY LICIENCE UNDER ITS PATENT RIGHTS, NOR THE RIGHTS OF OTHERS.

THE GRAPHS PROVIDED IN THIS DOCUMENT ARE STATISTICAL SUMMARIES BASED ON A LIMITED NUMBER OF SAMPLES AND ARE PROVIDED FOR INFORMATIONAL PURPOSE ONLY. THE PERFORMANCE CHARACTERISTICS LISTED IN THEM ARE NOT TESTED OR GUARANTEED. IN SOME GRAPHS, THE DATA PRESENTED MAY BE OUTSIDE THE SPECIFIED OPERATING RANGE (E.G., OUTSIDE SPECIFIED POWER SUPPLY RANGE) AND THEREFORE OUTSIDE THE WARRANTED RANGE.