



SSC8334GSB

Dual N-Channel Enhancement MOSFET

➤ Features

VDS	VGS	RDSON Typ.	ID	ESD
30V	±12V	450mR@4V5	1A	1.2KV
		520mR@2V5		

➤ Pin configuration

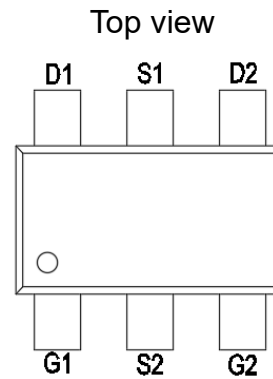

➤ Description

SSC8334GSB uses advanced trench technology to provide excellent RDSON and low gate charge. The complementary MOSFETS may be used to form a level shifted high side switch, and for a host of other applications.

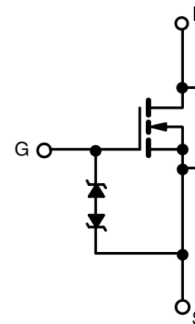

➤ Applications

- Small signal switch
- Load switch
- Digital Transistors

➤ Ordering Information

Device	Package	Shipping
SSC8334GSB	SOT23-6L	3000/Reel

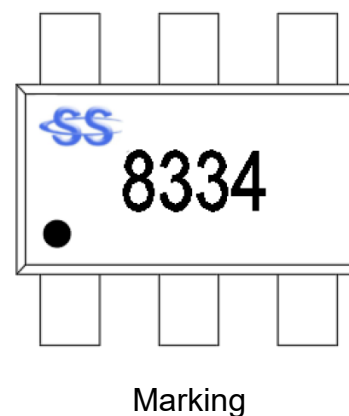



➤ **Absolute Maximum Ratings**($T_A=25^{\circ}\text{C}$ unless otherwise noted)

Symbol	Parameter	Ratings	Unit
V_{DSS}	Drain-to-Source Voltage	30	V
V_{GSS}	Gate-to-Source Voltage	± 12	V
I_D	Continuous Drain Current ^a	1	A
I_{DM}	Pulsed Drain Current ^b	3	A
P_{DSM}	Power Dissipation ^a	0.8	W
P_D	Power Dissipation ^c	0.3	W
T_J	Operation junction temperature	-55 to 150	$^{\circ}\text{C}$
T_{STG}	Storage temperature range	-55 to 150	$^{\circ}\text{C}$

➤ **Thermal Resistance Ratings**($T_A=25^{\circ}\text{C}$ unless otherwise noted)

Symbol	Parameter	Typical	Unit
$R_{\theta JA}$	Junction-to-Ambient Thermal Resistance ^a	420	$^{\circ}\text{C}/\text{W}$
$R_{\theta JC}$	Junction-to-Case Thermal Resistance	160	

Note:

- The value of $R_{\theta JA}$ is measured with the device mounted on 1 in² FR-4 board with 2oz.copper,in a still air environment with $T_A=25^{\circ}\text{C}$.The value in any given application depends on the user is specific board design. The current rating is based on the $t \leq 10\text{s}$ thermal resistance rating.
- Repetitive rating, pulse width limited by junction temperature.
- The power dissipation P_D is based on $T_{J(MAX)}=150^{\circ}\text{C}$, using junction-to-case thermal resistance, and is more useful in setting the upper dissipation limit for cases where additional heat sinking is used.



➤ **Electronics Characteristics**($T_A=25^{\circ}\text{C}$ unless otherwise noted)

Symbol	Parameter	Test Conditions	Min	Typ.	Max	Unit
$V_{(BR)DSS}$	Drain-Source Breakdown Voltage	$V_{GS}=0V, I_D=250\mu A$	30			V
$V_{GS(th)}$	Gate Threshold Voltage	$V_{DS}=V_{GS}, I_D=250\mu A$	0.6	1	1.3	V
$R_{DS(on)}$	Drain-Source On- Resistance	$V_{GS}=4.5V, I_D=1A$		450	700	mR
		$V_{GS}=2.5V, I_D=1A$		520	900	
		$V_{GS}=1.8V, I_D=0.5A$		950	1500	
I_{DSS}	Zero Gate Voltage Drain Current	$V_{DS}=24V, V_{GS}=0V$			1	μA
I_{GSS}	Gate-Source leak current	$V_{GS}=\pm 10V, V_{DS}=0V$			± 10	μA
G_{FS}	Transconductance	$V_{DS}=5V, I_D=1A$		1		S
V_{SD}	Forward Voltage	$V_{GS}=0V, I_S=1A$		0.9	1.3	V
C_{iss}	Input Capacitance	$V_{DS}=15V, V_{GS}=0V,$ $f=1MHz$		62		pF
C_{oss}	Output Capacitance			16		
C_{rss}	Reverse Transfer Capacitance			4		
Q_g	Total Gate Charge	$V_{DS}=15V, V_{GS}=4.5V,$ $I_D=3.8A$		1		nC
Q_{gs}	Gate Source Charge			0.3		
Q_{gd}	Gate Drain Charge			0.2		
$T_{D(ON)}$	Turn-on delay time	$V_{DS}=15V, V_{GS}=6V,$ $R_L=30R, R_{GEN}=1R$		3		ns
T_r	Rise time			14		
$T_{D(OFF)}$	Turn-off delay time			11		
T_f	Fall time			9		



➤ **N-Channel Typical Characteristics**($T_A=25^\circ\text{C}$ unless otherwise noted)

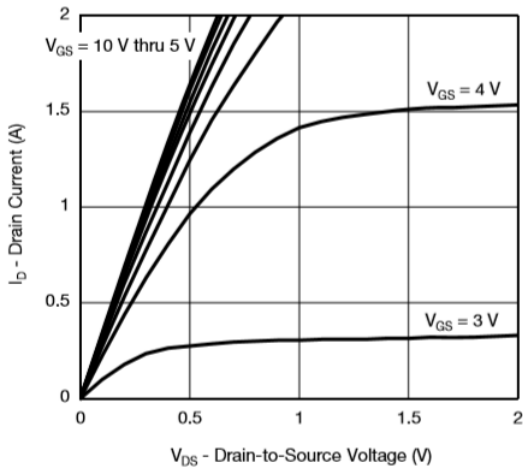

Output Characteristics

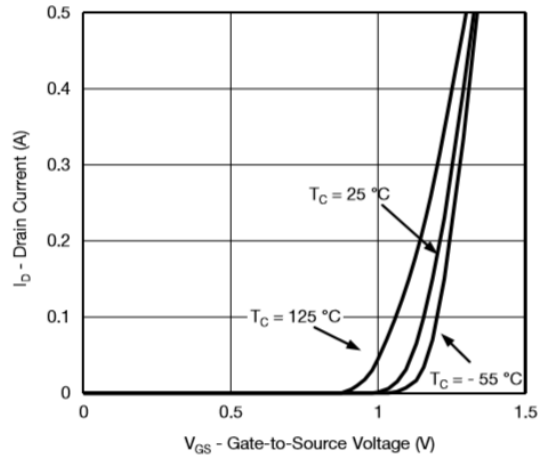

Transfer Characteristics

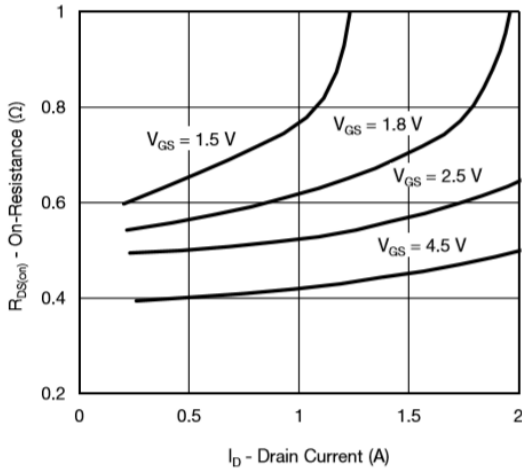

On-Resistance vs. Drain Current

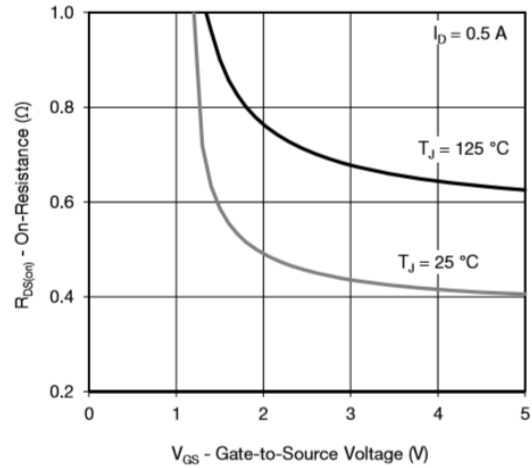

On-Resistance vs. Gate-to-Source Voltage

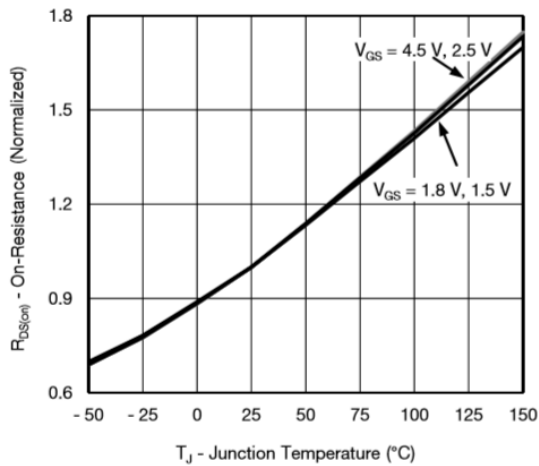

On-Resistance vs. Junction Temperature

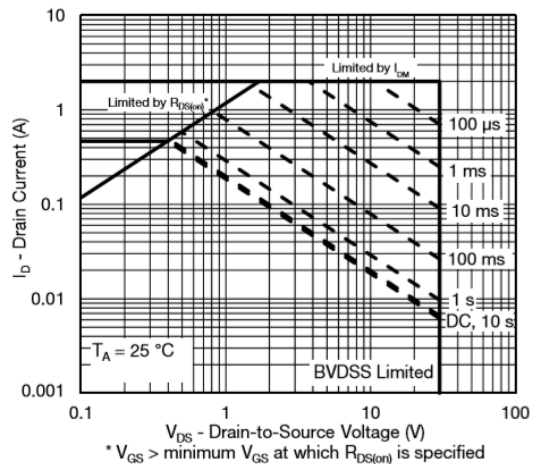

Safe Operating Area, Junction-to-Ambient



➤ Package Information

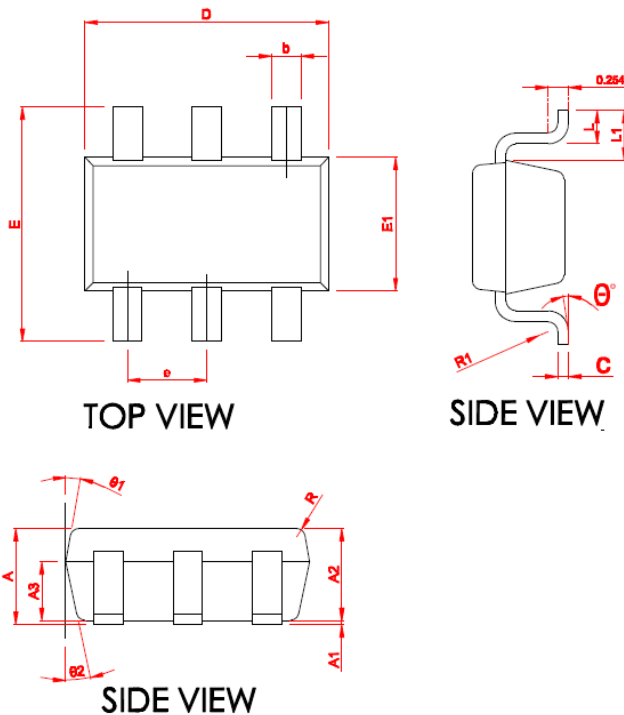

SYMBOL	MILLIMETER		
	MIN	NOM	MAX
A	1.06	1.15	1.24
* A1	0.01	0.05	0.09
* A2	1.05	1.10	1.15
A3	0.65	0.70	0.75
* b	0.30	0.35	0.45
* c	0.117	0.127	0.157
* D	2.87	2.92	2.97
* E	2.72	2.80	2.88
* E1	1.55	1.60	1.65
* e	0.90	0.95	1.00
* L	0.32	0.40	0.48
* L1	0.55	0.60	0.65
R	0.10 REF		
R1	0.12 REF		
* θ	0	--	8°
θ1	8°	10°	12°
θ2	10°	12°	14°

DISCLAIMER

AFSEMI RESERVES THE RIGHT TO MAKE CHANGES WITHOUT FURTHER NOTICE TO ANY PRODUCTS HEREIN TO IMPROVE RELIABILITY, FUNCTION OR DESIGN. AFSEMI DOES NOT ASSUME ANY LIABILITY ARISING OUT OF THE APPLICATION OR USE OF ANY PRODUCT OR CIRCUIT DESCRIBED HEREIN; NEITHER DOES IT CONVEY ANY LICIENCE UNDER ITS PATENT RIGHTS, NOR THE RIGHTS OF OTHERS.

THE GRAPHS PROVIDED IN THIS DOCUMENT ARE STATISTICAL SUMMARIES BASED ON A LIMITED NUMBER OF SAMPLES AND ARE PROVIDED FOR INFORMATIONAL PURPOSE ONLY. THE PERFORMANCE CHARACTERISTICS LISTED IN THEM ARE NOT TESTED OR GUARANTEED. IN SOME GRAPHS, THE DATA PRESENTED MAY BE OUTSIDE THE SPECIFIED OPERATING RANGE (E.G. OUTSIDE SPECIFIED POWER SUPPLY RANGE) AND THEREFORE OUTSIDE THE WARRANTED RANGE.