



## SSC8130GQ4

### N-Channel Enhanced MOSFET

#### ➤ Features

VDS	VGS	RDSON Typ.	ID
30V	±20V	6mR@10V	45A
		9mR@4V5	

#### ➤ Description

This device is N-Channel enhancement MOSFET. Uses advanced trench technology and design to provide excellent RDSON with low gate charge. This device is suitable for use in DC-DC conversion, power switch and charging circuit.

#### ➤ Applications

- DC/DC converters
- Power supplies
- Motor Drive Control
- Synchronous rectification

#### ➤ Ordering Information

Device	Package	Shipping
SSC8130GQ4	DFN3X3	5000/Reel

#### ➤ Pin configuration

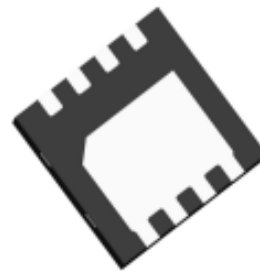
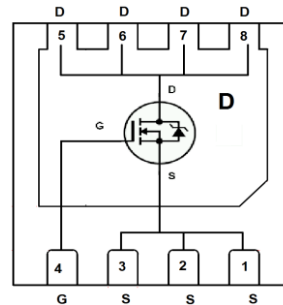

Bottom View

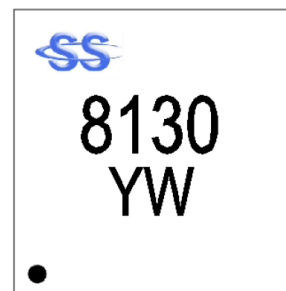

Marking

(Y: product year / W: product week)



➤ **Absolute Maximum Ratings**( $T_A=25^{\circ}\text{C}$  unless otherwise noted)

Symbol	Parameter	Ratings	Unit	
$V_{DSS}$	Drain-to-Source Voltage	30	V	
$V_{GSS}$	Gate-to-Source Voltage	$\pm 20$	V	
$I_D$	Continuous Drain Current <sup>d</sup>	$T_C=25^{\circ}\text{C}$	45	A
		$T_C=100^{\circ}\text{C}$	28	
$I_{DSM}$	Continuous Drain Current <sup>a</sup>	$T_A=25^{\circ}\text{C}$	24	A
		$T_A=70^{\circ}\text{C}$	16	
$I_{DM}$	Pulsed Drain Current <sup>b</sup>	180	A	
$P_D$	Power Dissipation <sup>c</sup>	$T_C=25^{\circ}\text{C}$	26	W
		$T_C=100^{\circ}\text{C}$	10.5	
$P_{DSM}$	Power Dissipation <sup>a</sup>	$T_A=25^{\circ}\text{C}$	3.5	W
		$T_A=70^{\circ}\text{C}$	2.2	
$I_{AS}$	Avalanche Current <sup>b</sup> L=0.5mH Single Pulse	25	A	
$E_{AS}$	Avalanche Energy <sup>b</sup> L=0.5mH Single Pulse	156	mJ	
$T_J$	Operation junction temperature	-55~150	$^{\circ}\text{C}$	
$T_{STG}$	Storage temperature range	-55~150		

➤ **Thermal Resistance Ratings**( $T_A=25^{\circ}\text{C}$  unless otherwise noted)

Symbol	Parameter	Ratings	Unit
$R_{\theta JA}$	Junction-to-Ambient Thermal Resistance <sup>a</sup>	36	$^{\circ}\text{C}/\text{W}$
$R_{\theta JC}$	Junction-to-Case Thermal Resistance	4.75	

Note:

- The value of  $R_{\theta JA}$  is measured with the device mounted on 1 in<sup>2</sup> FR-4 board with 2oz.copper, in a still air environment with  $T_A=25^{\circ}\text{C}$ . The value in any given application depends on the user is specific board design. The power dissipation is based on the  $t \leq 10\text{s}$  thermal resistance rating.
- Repetitive rating, pulse width limited by junction temperature.
- The power dissipation  $P_D$  is based on  $T_{J(\text{MAX})}=150^{\circ}\text{C}$ , using junction-to-case thermal resistance, and is more useful in setting the upper dissipation limit for cases where additional heat sinking is used.
- The maximum current rating is package limited.



➤ **Electronics Characteristics**( $T_A=25^{\circ}\text{C}$  unless otherwise noted)

Symbol	Parameter	Test Conditions	Min	Typ.	Max	Unit
$V_{(BR)DSS}$	Drain-Source Breakdown Voltage	$V_{GS}=0V, I_D=250\mu A$	30			V
$V_{GS(th)}$	Gate Threshold Voltage	$V_{DS}=V_{GS}, I_D=250\mu A$	1	1.7	3	V
$R_{DS(on)}$	Drain-Source On-Resistance	$V_{GS}=10V, I_D=20A$		6	8.5	mR
		$V_{GS}=4.5V, I_D=10A$		9	12.5	
$I_{DSS}$	Zero Gate Voltage Drain Current	$V_{DS}=24V, V_{GS}=0V$			1	$\mu A$
$I_{GSS}$	Gate-Source leak current	$V_{GS}=\pm 20V, V_{DS}=0V$			$\pm 100$	nA
$G_{FS}$	Transconductance	$V_{DS}=5V, I_D=10A$		17		S
$V_{SD}$	Forward Voltage	$V_{GS}=0V, I_S=5A$		0.78	1.3	V
$C_{iss}$	Input Capacitance	$V_{DS}=15V, V_{GS}=0V,$ $f=1MHz$		2270		pF
$C_{oss}$	Output Capacitance			220		
$C_{rss}$	Reverse Transfer Capacitance			102		
$T_{D(ON)}$	Turn-on delay time	$V_{GS}=10V, R_L=3R$ $V_{DS}=15V, R_G=1R$		15		ns
$T_r$	Rise time			7		
$T_{D(OFF)}$	Turn-off delay time			25		
$T_f$	Fall time			6		
$Q_G$	Total Gate Charge	$V_{GS}=10V, V_{DS}=15V$ $I_D=20A$		26		nC
$Q_{GS}$	Gate Source Charge			12		
$Q_{GD}$	Gate Drain Charge			5.4		
$T_{rr}$	Diode Recovery Time	$I_F=10A, di/dt=100A/\mu s$		40		ns
$Q_{rr}$	Diode Recovery Charge	$I_F=10A, di/dt=100A/\mu s$		55		nC



➤ **Typical Characteristics** ( $T_A=25^\circ\text{C}$  unless otherwise noted)

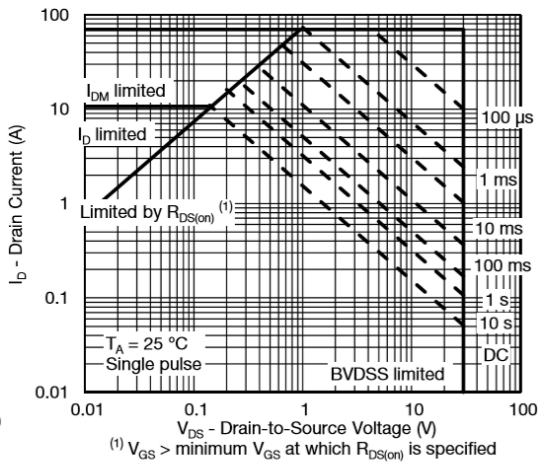
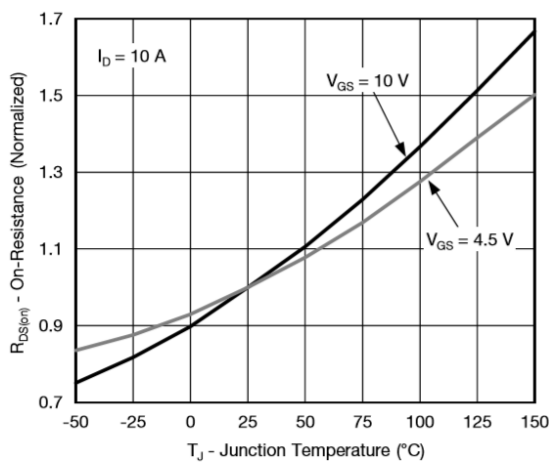
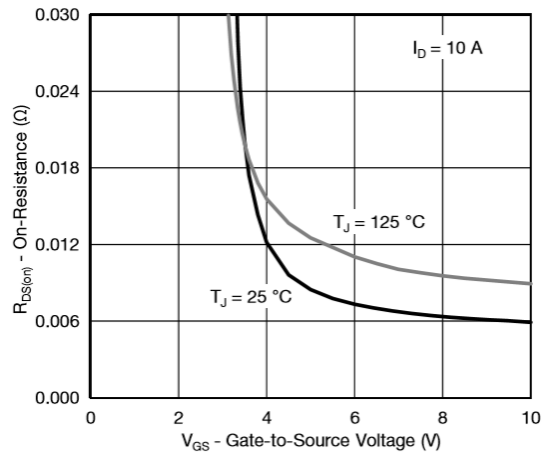
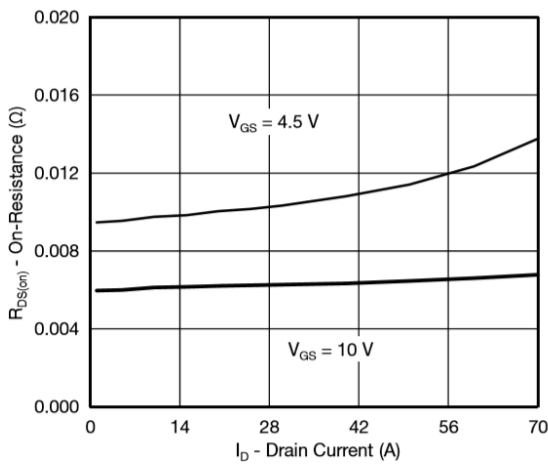
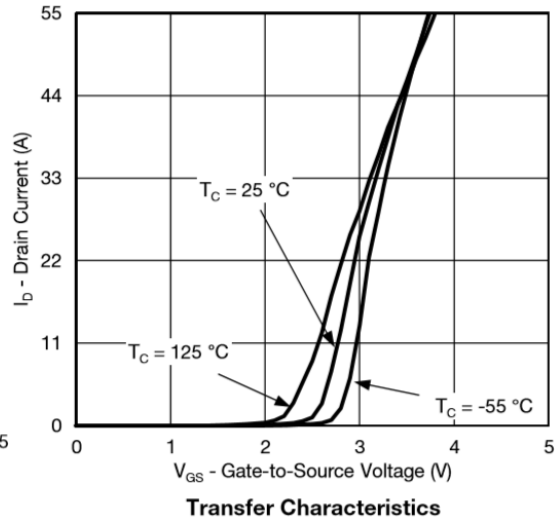
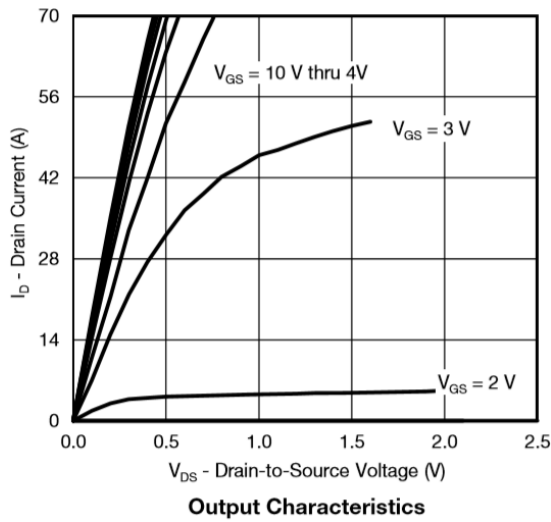



➤ Package Information

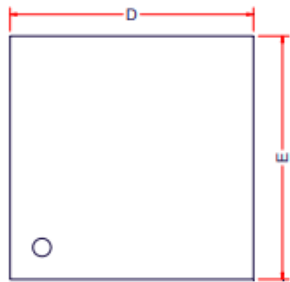

TOP VIEW

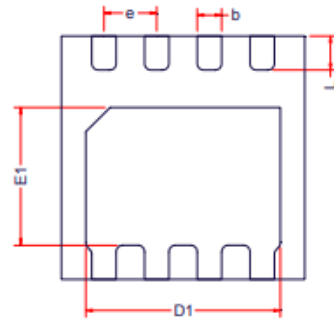

BOTTOM VIEW

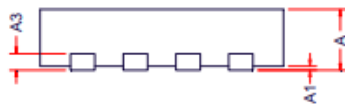

SIDE VIEW

Package: DNF3X3-8L

Symbol	Dimensions in Millimeters		
	Min.	Typ.	Max.
A	0.70	0.75	0.80
A1	0.00	0.02	0.05
A2	0.20Ref		
D	2.90	3.00	3.10
E	2.90	3.00	3.10
D1	2.35	2.40	2.45
E1	1.65	1.70	1.75
b	0.25	0.30	0.35
e	0.65BSC		
L	0.37	0.42	0.47



➤ Tape and Reel

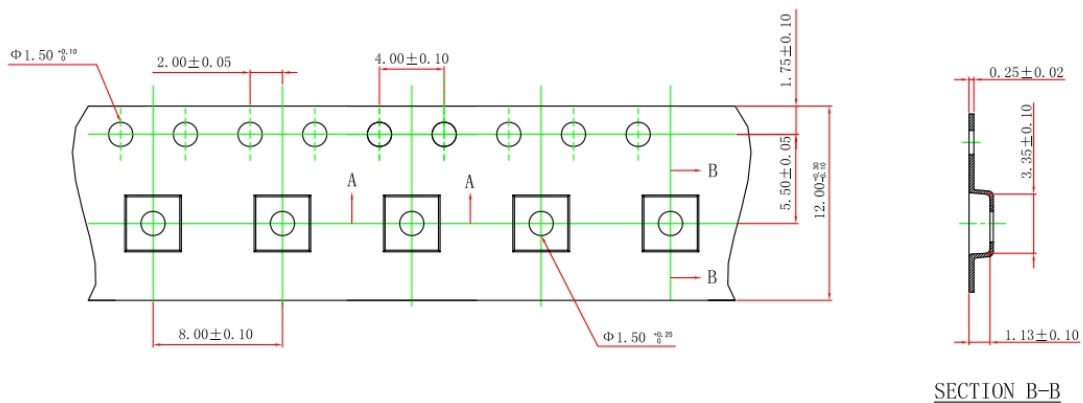
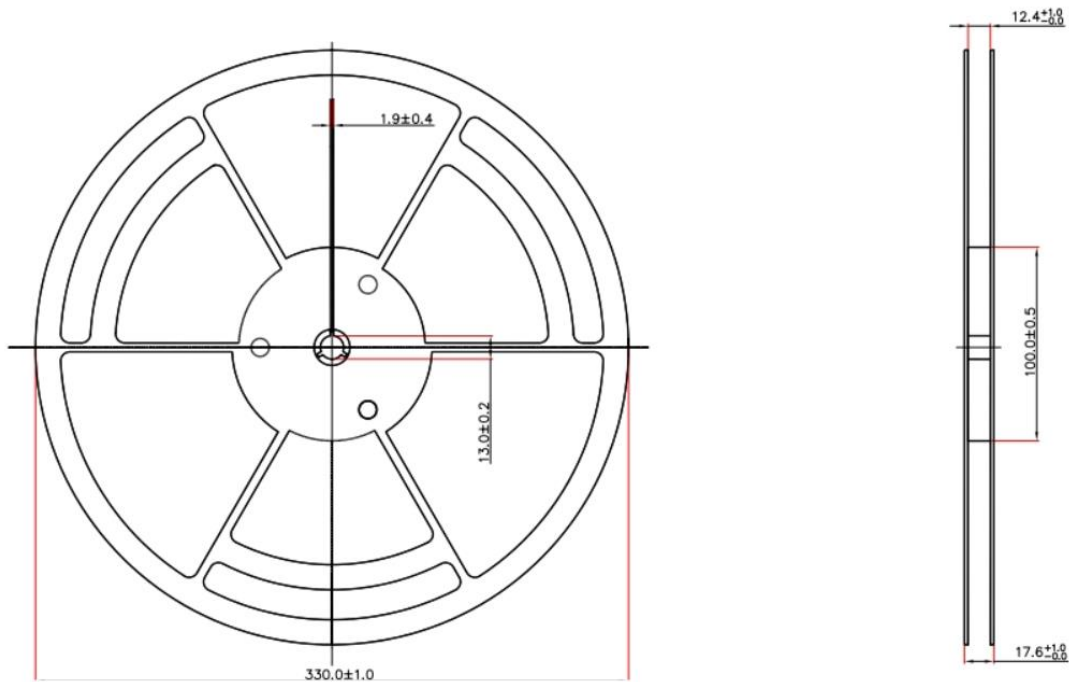

SECTION B-B

**DISCLAIMER**

AFSEMI RESERVES THE RIGHT TO MAKE CHANGES WITHOUT FURTHER NOTICE TO ANY PRODUCTS HEREIN TO IMPROVE RELIABILITY, FUNCTION OR DESIGN. AFSEMI DOES NOT ASSUME ANY LIABILITY ARISING OUT OF THE APPLICATION OR USE OF ANY PRODUCT OR CIRCUIT DESCRIBED HEREIN; NEITHER DOES IT CONVEY ANY LICIENCE UNDER ITS PATENT RIGHTS, NOR THE RIGHTS OF OTHERS.

THE GRAPHS PROVIDED IN THIS DOCUMENT ARE STATISTICAL SUMMARIES BASED ON A LIMITED NUMBER OF SAMPLES AND ARE PROVIDED FOR INFORMATIONAL PURPOSE ONLY. THE PERFORMANCE CHARACTERISTICS LISTED IN THEM ARE NOT TESTED OR GUARANTEED. IN SOME GRAPHS, THE DATA PRESENTED MAY BE OUTSIDE THE SPECIFIED OPERATING RANGE (E.G. OUTSIDE SPECIFIED POWER SUPPLY RANGE) AND THEREFORE OUTSIDE THE WARRANTED RANGE.