



SSC8080GT4

N-Channel Enhanced MOSFET

➤ Features

VDS	VGS	RDSON Typ.	ID
80V	±25V	6.8mR@10V	97A

➤ Description

This device is N-Channel enhancement MOSFET. Uses advanced trench technology and design to provide excellent RDSON with low gate charge. This device is suitable for use in DC-DC conversion, power switch and charging circuit.

➤ Applications

- DC/DC converters
- Power supplies
- Motor Drive Control
- Synchronous rectification

➤ Ordering Information

Device	Package	Shipping
SSC8080GT4	TO-220-3L	50/Tube

➤ Pin configuration

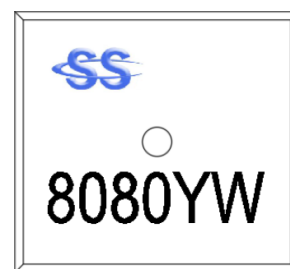
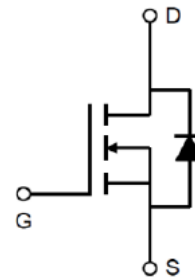
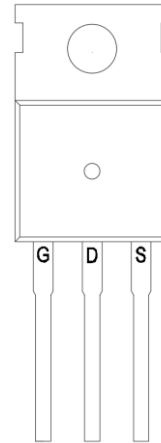

Marking

(Y:Product Year/W: Product Week)



➤ **Absolute Maximum Ratings**($T_A=25^{\circ}\text{C}$ unless otherwise noted)

Symbol	Parameter	Ratings	Unit	
V_{DSS}	Drain-to-Source Voltage	80	V	
V_{GSS}	Gate-to-Source Voltage	± 25	V	
I_D	Continuous Drain Current ^d	$T_C=25^{\circ}\text{C}$	97	A
		$T_C=100^{\circ}\text{C}$	42	
I_{DSM}	Continuous Drain Current ^a	$T_A=25^{\circ}\text{C}$	37	A
		$T_A=70^{\circ}\text{C}$	25	
I_{DM}	Pulsed Drain Current ^b	388	A	
P_D	Power Dissipation ^c	$T_C=25^{\circ}\text{C}$	104	W
		$T_C=100^{\circ}\text{C}$	41	
P_{DSM}	Power Dissipation ^a	$T_A=25^{\circ}\text{C}$	15	W
		$T_A=70^{\circ}\text{C}$	10	
I_{AS}	Avalanche Current ^b L=0.5mH Single Pulse	40	A	
E_{AS}	Avalanche Energy ^b L=0.5mH Single Pulse	400	mJ	
T_J	Operation junction temperature	-55~150	$^{\circ}\text{C}$	
T_{STG}	Storage temperature range	-55~150		

➤ **Thermal Resistance Ratings**($T_A=25^{\circ}\text{C}$ unless otherwise noted)

Symbol	Parameter	Ratings	Unit
$R_{\theta JA}$	Junction-to-Ambient Thermal Resistance ^a	8	$^{\circ}\text{C}/\text{W}$
$R_{\theta JC}$	Junction-to-Case Thermal Resistance	1.2	

Note:

- The value of $R_{\theta JA}$ is measured with the device mounted on 1 in² FR-4 board with 2oz.copper, in a still air environment with $T_A=25^{\circ}\text{C}$. The value in any given application depends on the user is specific board design. The power dissipation is based on the $t \leq 10\text{s}$ thermal resistance rating.
- Repetitive rating, pulse width limited by junction temperature.
- The power dissipation P_D is based on $T_{J(\text{MAX})}=150^{\circ}\text{C}$, using junction-to-case thermal resistance, and is more useful in setting the upper dissipation limit for cases where additional heat sinking is used.
- The maximum current rating is package limited.



➤ **Electronics Characteristics**($T_A=25^{\circ}\text{C}$ unless otherwise noted)

Symbol	Parameter	Test Conditions	Min	Typ.	Max	Unit
$V_{(BR)DSS}$	Drain-Source Breakdown Voltage	$V_{GS}=0V, I_D=250\mu A$	80			V
$V_{GS(th)}$	Gate Threshold Voltage	$V_{DS}=V_{GS}, I_D=250\mu A$	2	3	4	V
$R_{DS(on)}$	Drain-Source On-Resistance	$V_{GS}=10V, I_D=30A$		6.8	9	mR
I_{DSS}	Zero Gate Voltage Drain Current	$V_{DS}=80V, V_{GS}=0V$			1	μA
I_{GSS}	Gate-Source leak current	$V_{GS}=\pm 25V, V_{DS}=0V$			± 100	nA
G_{FS}	Transconductance	$V_{DS}=20V, I_D=10A$		26		S
V_{SD}	Forward Voltage	$V_{GS}=0V, I_S=10A$		0.76	1.3	V
C_{iss}	Input Capacitance	$V_{DS}=40V, V_{GS}=0V,$ $f=1\text{MHz}$		5000		pF
C_{oss}	Output Capacitance			1400		
C_{rss}	Reverse Transfer Capacitance			122		
$T_{D(ON)}$	Turn-on delay time	$V_{GS}=10V, R_L=2R$ $V_{DS}=40V, R_G=1R$		22		ns
T_r	Rise time			24		
$T_{D(OFF)}$	Turn-off delay time			34		
T_f	Fall time			14		
Q_G	Total Gate Charge	$V_{GS}=10V, V_{DS}=40V$ $I_D=20A$		68		nC
Q_{GS}	Gate Source Charge			15		
Q_{GD}	Gate Drain Charge			13		
T_{rr}	Diode Recovery Time	$I_F=30A, di/dt=100A/\mu s$		94		ns
Q_{rr}	Diode Recovery Charge	$I_F=30A, di/dt=100A/\mu s$		154		nC



➤ **Typical Characteristics** ($T_A = 25^\circ\text{C}$ unless otherwise noted)

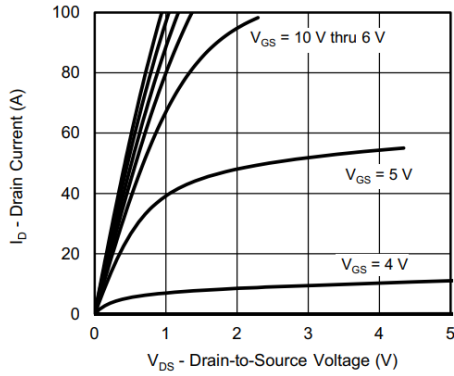

Output Characteristics

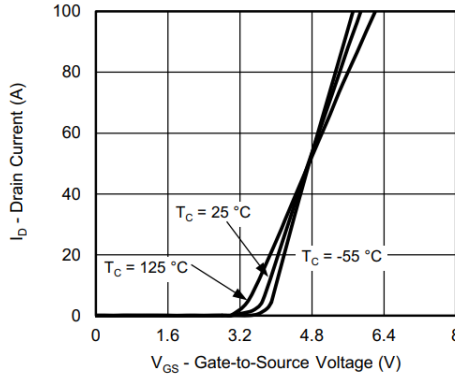

Transfer Characteristics

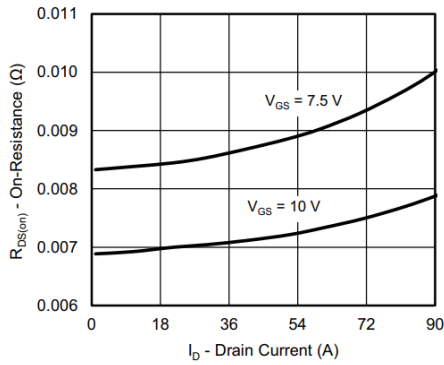

On-Resistance vs. Drain Current and Gate Voltage

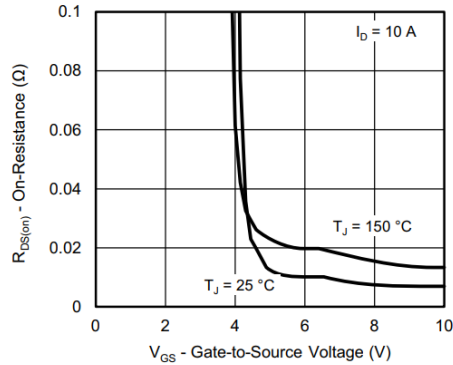

On-Resistance vs. Gate-to-Source Voltage

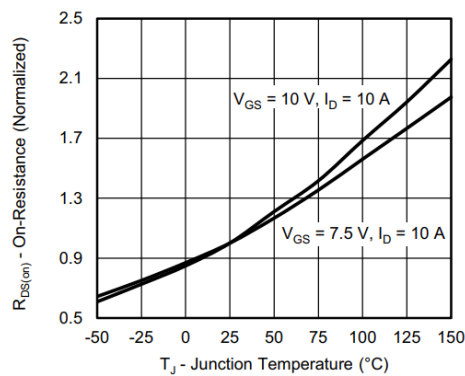

On-Resistance vs. Junction Temperature

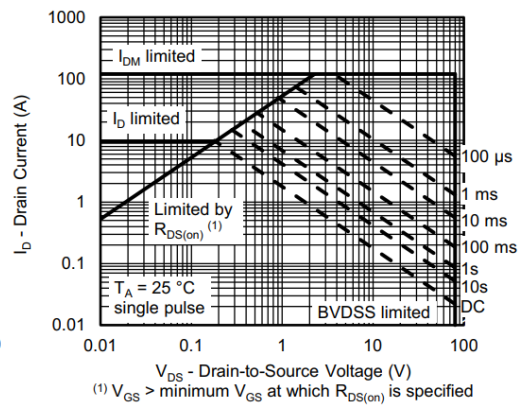

Safe Operating Area, Junction-to-Ambient



➤ Package Information

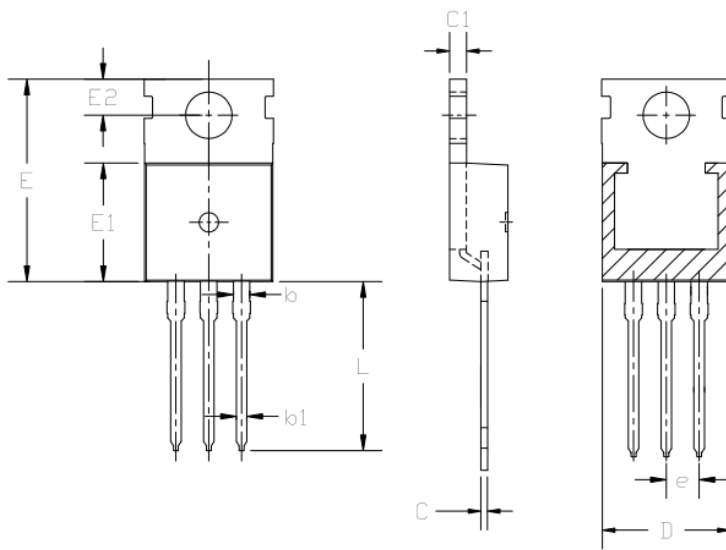

SYMBOL	MILLIMETER		
	MIN	NOM	MAX
A	4.40	--	4.60
b	1.20	--	1.36
b1	0.70	--	0.90
C	0.48	--	0.53
C1	1.28	--	1.32
D	9.80	10.00	10.20
E	15.20	15.45	15.75
E1	9.00	9.20	9.40
E2	2.60	--	2.90
e	--	2.54	--
L	13.00	--	13.40

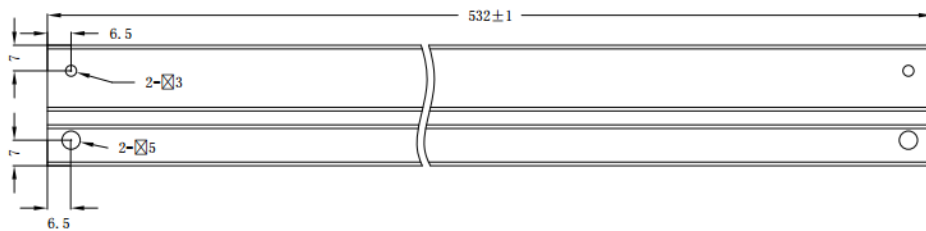
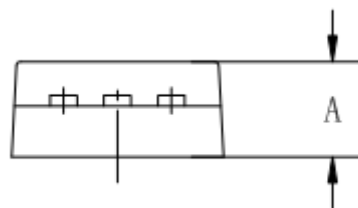

T=0.5 ±0.1

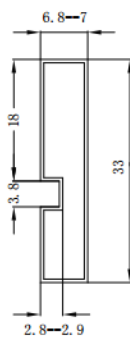

- 技术要求:
1. 材料: 透明PVC
 2. 表面电阻: 10E5~10E10 OHMS/SQ
 3. 未注尺寸公差±0.3
 4. 黑色钉子由厂家出货时塞于左端



DISCLAIMER

AFSEMI RESERVES THE RIGHT TO MAKE CHANGES WITHOUT FURTHER NOTICE TO ANY PRODUCTS HEREIN TO IMPROVE RELIABILITY, FUNCTION OR DESIGN. AFSEMI DOES NOT ASSUME ANY LIABILITY ARISING OUT OF THE APPLICATION OR USE OF ANY PRODUCT OR CIRCUIT DESCRIBED HEREIN; NEITHER DOES IT CONVEY ANY LICENCE UNDER ITS PATENT RIGHTS, NOR THE RIGHTS OF OTHERS.

THE GRAPHS PROVIDED IN THIS DOCUMENT ARE STATISTICAL SUMMARIES BASED ON A LIMITED NUMBER OF SAMPLES AND ARE PROVIDED FOR INFORMATIONAL PURPOSE ONLY. THE PERFORMANCE CHARACTERISTICS LISTED IN THEM ARE NOT TESTED OR GUARANTEED. IN SOME GRAPHS, THE DATA PRESENTED MAY BE OUTSIDE THE SPECIFIED OPERATING RANGE (E.G. OUTSIDE SPECIFIED POWER SUPPLY RANGE) AND THEREFORE OUTSIDE THE WARRANTED RANGE.